

# Franke Specialist Range

Innovative designs with style



For kitchens without compromise.

**FRANKE**

KITCHEN  
SYSTEMS



## With the Franke Specialist Range, we have drawn upon all of our experience to craft an inspirational collection that combines design excellence with style.

This superb choice of state-of-the art sink designs is offered in a wide range of durable materials, shapes and sizes. Whether you seek a cutting edge contemporary or modern classic look, a selection of elegant taps is available to fully complement each individual style.

---

Franke has been at the forefront of kitchen sink innovation since the company was founded in Switzerland almost a century ago. Since then we've established efficient and economic manufacturing facilities all around the world. These allow us to offer competitively priced products and still maintain immaculate standards of design, production and high-grade materials.

### Coordinating Designer Packs

To make our quality even more affordable and to help you choose from the extensive Specialist Range, we've devised coordinating Designer Packs. Each pack comprises a sink, a complementary tap, and in some cases matching accessories to form the perfect package. However, we still want to offer you as much flexibility as possible, so feel free to select the tap of your choice from the full range shown on pages 38-47.

### Peace of mind with Franke quality

We have absolute confidence in the unparalleled quality of our sinks. That's why we offer a 50 year guarantee against any manufacturing defects.



# Stainless Steel Inset Sinks

## Immaculate in both form and function

Made from premium quality chrome nickel steel – the perfect material for ensuring cleanliness and hygiene. These sinks look beautiful, are resistant to staining, chipping, rust and corrosion. Available in a number of finishes – including silk, brushed, linen and 'Microdekor' – a warm, subtle surface that's delightful to touch.

- Available in a variety of styles to suit your kitchen
- Hardwearing and hygienic
- Sleek, elegant styling
- Shown with complementary tap designs



## Compact

CPX 611 780 Stainless Steel & Davos 'J' Chrome tap

3 WEEK DELIVERY

The classic symmetrical bowl and drainer in a compact format.

Pictured Sink 101.0066.066  
Pictured Tap 115.0050.044



Cabinet width  
450mm

Finish



Silk

RHD 101.0066.080

Available at extra cost



Drainer Tray\*  
€28

White 112.0038.356  
Almond 112.0038.244  
Brown 112.0038.350



Drainer Basket\*  
€53

White 112.0050.247  
Almond 112.0050.249  
Brown 112.0050.248



Plate rack  
extra\* €13

White 112.0050.250  
Almond 112.0050.252  
Brown 112.0050.251  
Black 112.0050.246

\*Available in White,  
Almond, Black & Brown



Food Preparation  
Platter  
€85

112.0050.264

Suggested Alternative Tap  
All tap options  
on p38-49



Davos 'J'  
in SilkSteel  
€215

115.0049.940

Suggested WDU  
All WDU options on p53



Franke Turbo  
WDU-500  
€298

134.0049.848

Plumbing Kit  
Siphon I plumbing  
kit available  
€24



112.0059.946

Sink Only Price

CPX 611 780  
€430

Tap Only Price

€185

## Compact

CRX 651 Stainless Steel & Davos 'J' Chrome tap

A reversible bowl and a half based on the original Compact design. Plug and chain supplied in main bowl.

Pictured Sink 101.0018.860  
Pictured Tap 115.0050.044



Cabinet width  
600mm

Finish



Silk

101.0018.860

Compact CRX 651 pack includes:

\*Available in White, Almond & Brown



Strainer Bowl\*  
€21

White Pack 112.0050.424  
Brown Pack 112.0050.423



Drainer Basket\*  
€53

Almond Pack 112.0050.422



Food €85

Preparation  
Platter

Suggested Alternative TAP  
All tap options  
on p38-49



Davos 'J'  
in SilkSteel  
€215

115.0049.940

Suggested WDU  
All WDU options on p53



Franke Turbo  
WDU-500  
€298

134.0049.848

Plumbing Kit  
Siphon II plumbing  
kit available  
€36



112.0052.536

Sink Only Price

CRX 651  
€293

Tap Only Price

€185

## Compact Nova

CNX 660 Stainless Steel & Davos 'J' Chrome tap

Even with the larger half bowl size, this combination still fits into a 600mm cabinet.

NB. Only available with right hand small bowl.

Pictured Sink 101.0066.051  
Pictured Tap 115.0050.044



3 WEEK DELIVERY

### Suggested Alternative Tap

All tap options on p38-49

Davos 'J' in SilkSteel  
€215  
115.0049.940



### Suggested WDU

All WDU options on p53

Franke Turbo WDU-500  
€298  
134.0049.848



Plumbing Kit Siphon II plumbing kit available  
€36  
112.0052.536

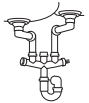

### Sink Only Price

CNX 660  
€351

### Tap Only Price

€185

Cabinet width  
600mm

Finish

 Silk RHSB 101.0066.051

Available at extra cost  
\*Available in White, Almond, Brown & Black



Drainer Tray\*  
€28

White 112.0038.356  
Almond 112.0038.244  
Brown 112.0038.350



Drainer Basket\*  
€53

White 112.0050.247  
Almond 112.0050.249  
Brown 112.0050.248



Food Preparation Platter €85  
112.0050.264



Plate rack extra\*  
€13

White 112.0050.250  
Almond 112.0050.252  
Brown 112.0050.251  
Black 112.0050.246

## Infinito

INX 611 Stainless Steel & Davos 'J' Chrome tap

A very large bowl, single drainer sink at an affordable price.

Pictured Sink 101.0022.105  
Pictured Tap 115.0050.044



Cabinet width  
600mm

Finish

 Silk LHD 101.0022.105  
RHD 101.0022.104

†Available in White, Almond & Brown



Food Preparation Platter €86  
112.0050.263

### Suggested Alternative Tap

All tap options on p38-49

Davos 'J' in SilkSteel  
€215  
115.0049.940



### Suggested WDU

All WDU options on p53

Franke Turbo WDU-500  
€298  
134.0049.848



Plumbing Kit Siphon I plumbing kit available  
€24  
112.0059.946



### Sink Only Price

INX 611  
€255

### Tap Only Price

€185

## Ariane

ARX 654 Stainless Steel & Davos 'J' Chrome tap

Modern lines and bigger bowls make this sink a best selling model whilst still fitting into a 600mm base unit.

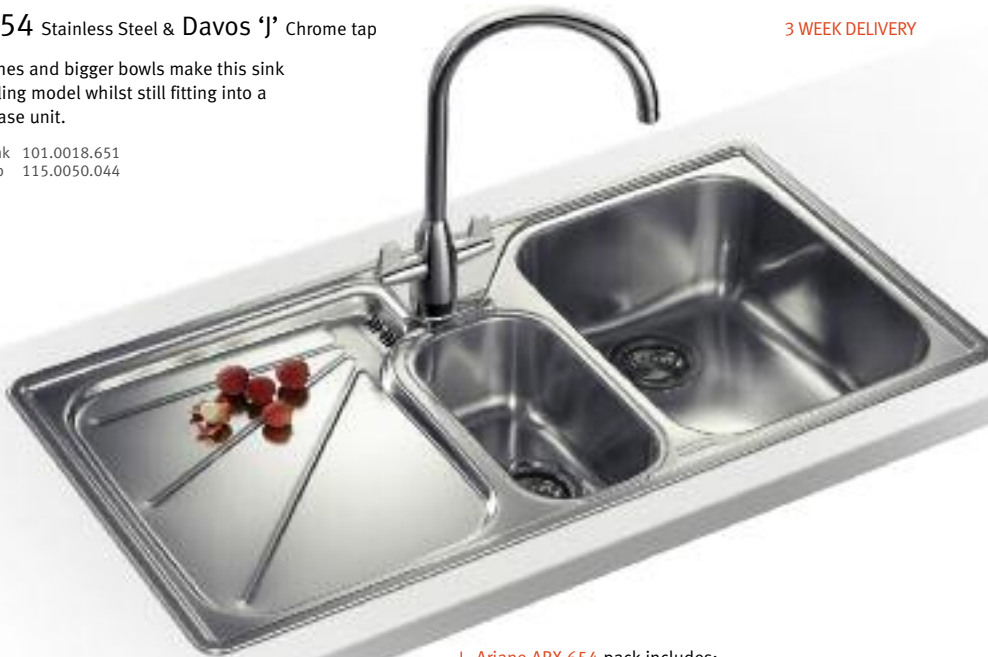

Pictured Sink 101.0018.651  
Pictured Tap 115.0050.044

3 WEEK DELIVERY





Cabinet width  
600mm

### Finish

	Silk	LHD 101.0018.651 RHD 101.0018.652
	Microdekor	LHD 101.0018.714 RHD 101.0018.715

Ariane ARX 654 pack includes:

	Strainer Bowl Stainless Steel	€102		Drainer Basket Stainless Steel	€121		Food Preparation Platter	€85
	Silk	112.0006.086		112.0050.241			112.0050.267	
	High Gloss	112.0006.090						

Suggested Alternative Tap  
All tap options  
on p38-49

Davos 'J'  
in SilkSteel  
€215  
115.0049.940



Suggested WDU  
All WDU options on p53

Franke Turbo  
WDU-500  
€298  
134.0049.848



### Sink Only Price

ARX 654 (Silk)  
€745

### Tap Only Price

€185

Plumbing Kit  
Siphon II plumbing  
kit available  
€36  
112.0052.536

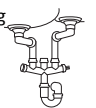

## Nobel

NOX 614 Stainless Steel & Davos 'J' Chrome tap

A symmetrical recessed drainer and large bowl that fits into a 500mm base unit.†

†Cabinet width may require modification to accommodate overflow.

Pictured Sink 101.0019.460  
Pictured Tap 115.0050.044

3 WEEK DELIVERY



Cabinet width  
500mm†

### Finish

	Silk	LHD 101.0019.460 RHD 101.0019.467
---	------	--------------------------------------



Food Preparation  
Platter €85  
112.0050.266

\*Available  
in White,  
Almond,  
Brown &  
Black

Suggested Alternative Tap  
All tap options  
on p38-49

Davos 'J'  
in SilkSteel  
€215  
115.0049.940



Suggested WDU  
All WDU options on p53

Franke Turbo  
WDU-500  
€298  
134.0049.848



### Sink Only Price

NOX 614  
€355

### Tap Only Price

€185

Plumbing Kit  
Siphon I plumbing  
kit available  
€24  
112.0059.946



UK

UKX 612 Stainless Steel & Davos 'J' Chrome tap\*

An original double drainer utilitarian English design.

Pictured Sink 101.0018.930  
Pictured Tap 115.0050.044



Cabinet width  
500mm

Finish  
Silk 101.0018.930

Suggested Alternative Tap

All tap options  
on p38-49

Davos 'J'  
in SilkSteel  
€215  
115.0049.940



Suggested WDU

All WDU options on p53

Franke Turbo  
WDU-500  
€298  
134.0049.848



Plumbing Kit

Siphon I plumbing  
kit available

€24  
112.0059.946



Sink Only Price

UKX 612  
€453

Tap Only Price

€185

Beach Inset

BBX 651 Stainless Steel & Fuji Chrome tap

Revolutionary design with ergonomic principles  
make this sink very distinguishable.  
Includes twin pop-up waste.

Pictured Sink 101.0039.639  
Pictured Tap 115.0049.985

3 WEEK DELIVERY



Cabinet width  
600mm

Finish  
Silk 101.0039.639

Suggested Alternative Tap

All tap options  
on p38-49

Fuji  
Pull-out Nozzle  
in Chrome  
€321  
115.0049.987



Suggested WDU

All WDU options on p53

Franke Turbo  
WDU-500  
€298  
134.0049.848



Plumbing Kit

Siphon II plumbing  
kit available

€36  
112.0052.536

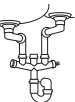

Sink Only Price\*

BBX 651  
€922

Tap Only Price

€270

Beach BBX 651 sink includes†:



Duo Bowl  
Stainless Steel  
112.0040.818



Measuring Bowl  
Stainless Steel  
112.0040.817



Food Preparation  
Platter Hygenia  
112.0036.731



Grille  
Stainless Steel  
112.0041.538



## Laser

### LSX 611 Stainless Steel & Eiger Chrome tap

In the innovative Laser single bowl sink, Franke has drawn on decades of experience to create an aesthetically appealing, super-slim edge profile design that is virtually flush with the work-surface.

Pictured Sink 101.0066.683  
Pictured Tap 115.0049.989



Cabinet width  
500mm

#### Finish



Silk LHD 101.0066.683  
RHD 101.0066.686

Available at extra cost



611 Sliding Glass Food Preparation Platter €96  
112.0039.129

Sink incorporates the revolutionary new Slimfix® clip system.



Suggested Alternative Tap  
All tap options on p38-49

Gotthard in Chrome  
€277  
115.0049.993



Suggested WDU  
All WDU options on p53

Franke Turbo WDU-500  
€298  
134.0049.848



Plumbing Kit Siphon I plumbing kit available  
€24  
112.0059.946



Sink Only Price

LSX 611  
€317

Tap Only Price

€257

## Laser

### LSX 651 Stainless Steel & Eiger Chrome tap

In the innovative Laser one and a half bowl sink, Franke has drawn on decades of experience to create an aesthetically appealing, super-slim edge profile design that is virtually flush with the work-surface.

Pictured Sink 101.0046.522  
Pictured Tap 115.0049.989



Cabinet width  
600mm

#### Finish



Silk LHD 101.0046.522  
RHD 101.0046.523

Available at extra cost



651 Sliding Glass Food Preparation Platter €116  
112.0039.124



Strainer Bowl Stainless Steel €102  
112.0041.519

Sink incorporates the revolutionary new Slimfix® clip system.



Suggested Alternative Tap  
All tap options on p38-49

Gotthard in Chrome  
€277  
115.0049.993



Suggested WDU  
All WDU options on p53

Franke Turbo WDU-500 add  
€298  
134.0049.848



Plumbing Kit Siphon II plumbing kit available  
€36  
112.0052.536



Sink Only Price

LSX 651  
€439

Tap Only Price

€257

## Planar

### PPX 611 Stainless Steel & Planar Chrome tap

Probably one of the most geometric single bowl single drainer inset sinks available, with zero radii bowls and plain drainer. Incorporates a square pop up waste control.

Pictured Sink 101.0045.976  
Pictured Tap 115.0049.999

3 WEEK DELIVERY

Cabinet width  
600mm

#### Finish

 Silk LHD 101.0045.976  
RHD 101.0050.482

Available at extra cost



Food Preparation Platter  
€86  
112.0016.488

#### Suggested Alternative Tap

All tap options on p38-49



Semi-Pro Vario Spray in Chrome  
€480  
115.0049.938

#### Suggested WDU

All WDU options on p53



Franke Turbo WDU-500  
€298  
134.0049.848

#### Plumbing Kit Siphon I plumbing kit available

€24  
112.0059.946



#### Sink Only Price

PPX 611  
€673

#### Tap Only Price

€432

## Planar

### PPX 651 Stainless Steel & Planar Chrome tap

All the style and benefits of the single bowl Planar but now in a one and a half bowl format. NB. If specifying a Waste Disposal Unit, this should be fitted in the large bowl. Includes pop-up waste.

Pictured Sink 101.0027.766  
Pictured Tap 115.0049.999

3 WEEK DELIVERY

Cabinet width  
600mm

#### Finish

 Silk LHD 101.0027.766  
RHD 101.0025.289

Available at extra cost



Food Preparation Platter  
€86  
112.0016.488

#### Suggested Alternative Tap

All tap options on p38-49



Semi-Pro Vario Spray in Chrome  
€480  
115.0049.938

#### Suggested WDU

All WDU options on p53



Franke Turbo WDU-500  
€298  
134.0049.848

#### Plumbing Kit Siphon II plumbing kit available

€36  
112.0052.536



#### Sink Only Price

PPX 651  
€812

#### Tap Only Price

€432

# Rotondo

## RBX 610 Stainless Steel & Davos 'J' SilkSteel tap

A practical round bowl for where space may be limited.

Pictured Sink 101.0033.751  
Pictured Tap 115.0049.940



Cabinet width  
500mm

### Finish

 Brushed 101.0033.751

### Rotondo RBX 610

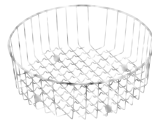

**Drainer Basket  
Stainless Steel** €152  
112.0050.639

### Rotondo RBX 604 Drainer



**Finish**  
 Polished €185  
101.0050.182

**Suggested Alternative Tap**  
All tap options  
on p38-49



**Orca  
in SilkSteel**  
€396  
115.0050.003

**Suggested WDU**  
All WDU options on p53

**Franke Turbo  
WDU-500**  
€298  
134.0049.848



### Sink Only Price

**RBX 610**  
€323

### Tap Only Price

€215

**Plumbing Kit  
Siphon I plumbing  
kit available**  
€24  
112.0059.946





# Mythos MMX Range

## Clean minimalist lines

### Mythos

**MMX 611** Stainless Steel & Mythos MTX Chrome tap

Fashioned and designed to fit into a 500mm base unit. Featuring an extra large single bowl with stunning good looks. Incorporating slide and glide glass food preparation platter and stainless steel strainer bowl.

Pictured Sink 101.0051.470  
Pictured Tap 115.0049.965

3 WEEK DELIVERY

**Suggested Alternative Tap**  
All tap options on p38-49

Mythos MTX in SilkSteel  
€413  
115.0049.966



**Suggested WDU**  
All WDU options on p53

Franke Turbo WDU-500  
€298  
134.0049.848



**Plumbing Kit**  
Siphon I plumbing kit available  
€24  
112.0059.946



**Sink Only Price\***

MMX 611  
€720

**Tap Only Price**

€387

Cabinet width 500mm

Finish



Silk LHD 101.0051.470  
RHD 101.0051.471

Mythos MMX 611 sink includes†:



Strainer Bowl  
Stainless Steel  
112.0017.788



Sliding Glass Food  
Preparation Platter  
112.0046.415

Available at extra cost



Rollamat 40  
€87  
112.0050.988

# Mythos

## MMX 651 Stainless Steel & Mythos MTX Chrome tap

This handed one and a half bowl option fits into a 600mm base to make efficient use of space and creating a design statement in the kitchen. Incorporating slide and glide glass food preparation platter and stainless steel strainer bowl.

Shown with optional Rollamat.

Pictured Sink 101.0051.473  
Pictured Tap 115.0049.965

3 WEEK DELIVERY



Cabinet width  
600mm

### Finish



Silk  
LHD 101.0051.473  
RHD 101.0051.475

### Mythos MMX 651 sink includes†:



Strainer Bowl  
Stainless Steel  
112.0017.788



Sliding Glass Food  
Preparation Platter  
112.0046.415



Rollamat 40  
€87  
112.0050.988

### Available at extra cost

### Suggested Alternative Tap

All tap options on p38-49

Mythos MTX  
in SilkSteel  
€413  
115.0049.966



### Suggested WDU

All WDU options on p53

Franke Turbo  
WDU-500  
€298  
134.0049.848



Plumbing Kit  
Siphon II plumbing  
kit available  
€36  
112.0052.536



### Sink Only Price†

MMX 651  
€840

### Tap Only Price

€387

# Fragranite Inset Sinks

Solid performance



- Highly durable
- New improved surface smoothness
- Shown with complementary tap designs
- Modern, minimalist Mythos range of Fraganite sinks

Fragranite is a unique material pioneered by Franke that contains 80% tough granite particles to resist burns, dents, chips and stains. Naturally textured, warm to the touch and with a subtle sheen, it comes in a wide range of colours with matching accessories and two different finishes. These are standard Fraganite and SilkSheen for a silkier finish.

## Mythos

MTG 611 Fraganite & Mythos MTG Graphite\* Chrome tap

7 WEEK DELIVERY

Designed with a geometric format this sink offers all the benefits of a jumbo bowl combined with very modern styling. Incorporating slide and glide glass food preparation platter and stainless steel strainer bowl.



\*NB: Mythos MTG tap available with Graphite or Polar White shoulders

Pictured Sink 114.0046.308  
Pictured Tap 115.0049.967



Cabinet width  
600mm

Finish SilkSheen

	Polar White	LHD 114.0045.906 RHD 114.0046.305
	Graphite	LHD 114.0046.308 RHD 114.0046.309

Mythos MTG 611 sink includes†:



Strainer Bowl  
Stainless Steel  
112.0018.817



Sliding Glass Food  
Preparation Platter  
112.0017.900



Rollamat 40  
€87  
112.0050.988

Available at extra cost

### Suggested Alternative Tap

All tap options  
on p38-49

Mythos MTG  
Graphite\* in  
SilkSteel  
€413  
115.0049.968



### Suggested WDU

All WDU options on p53

Franke Turbo  
WDU-500  
€298  
134.0049.848



Plumbing Kit  
Siphon I plumbing  
kit available  
€24  
112.0059.946



### Sink Only Price†

MTG 611  
€517

### Designer Pack Price

€387

# Mythos

**MTG 651-100** Fragranite & Mythos MTG Graphite\* Chrome tap

7 WEEK DELIVERY

The most sought after shape and design brought right up to date and with the benefit of resilient Fragranite material. Incorporating slide and glide glass food preparation platter and stainless steel strainer bowl.

\*NB: Mythos MTG tap available with Graphite or Polar White shoulders

Pictured Sink 114.0046.310  
Pictured Tap 115.0049.967



Cabinet width  
600mm

Finish SilkSheen



Graphite LHD 114.0046.310  
RHD 114.0046.311

Mythos MTG 651-100 sink includes†:



Strainer Bowl  
Stainless Steel  
112.0018.817



Sliding Glass Food  
Preparation Platter  
112.0017.900



Rollamat 40  
€87  
112.0050.988

Available at extra cost

### Suggested Alternative Tap

All tap options on p38-49

Mythos MTG Graphite\* in SilkSteel  
€413  
115.0049.968



### Suggested WDU

All WDU options on p53

Franke Turbo WDU-500  
€298  
134.0049.848



### Plumbing Kit

Siphon I plumbing kit available  
€24  
112.0059.946



### Sink Only Price†

MTG 651-100  
€542

### Tap Only Price

€387

# Kubus Glass Sinks

Sheer elegance



- Elegant, sophisticated and stylish
- Hardwearing, toughened glass
- Shown with complementary tap designs

Franke Kubus glass sinks are made from toughened glass and are able to cope with even the most demanding hardwearing environment. Perfect for that modernistic, aesthetic statement in the kitchen, the highly reflective perimeter surface and matt drainer area are available in either sleek Black or Aqua tones. They're clearly the last word in elegance. For more information and demonstration video visit [www.franke.co.uk](http://www.franke.co.uk)



## Kubus

### KBV 611 Glass & Mythos MTX SilkSteel tap

Revolutionary use of materials combining the hygienic qualities of stainless steel with the superb aesthetics of toughened glass. This single bowl model is easily accommodated in a 500mm cabinet. Available in Aqua or Black to complement many appliances. Includes pop-up waste.

Pictured Sink 101.0052.361  
Pictured Tap 115.0049.966

3 WEEK DELIVERY



Cabinet width  
500mm

#### Finish Glass

	Aqua	LHD 101.0052.361 RHD 101.0052.367
	Black	LHD 101.0052.390 RHD 101.0050.393

Alternative  
Colour



Available at extra cost



Strainer Bowl with handles  
Stainless Steel €98  
112.0014.123

Rollamat 40  
€87  
112.0050.988

Suggested Alternative Tap  
All tap options  
on p38-49

Franke Triflow  
Kubus in  
Chrome  
€776  
120.0050.032



Suggested WDU  
All WDU options on p53

Franke Turbo  
WDU-500  
€298  
134.0049.848



Plumbing Kit  
Siphon I plumbing  
kit available  
€24  
112.0059.946



#### Sink Only Price

KBV 611  
Aqua or Black  
€828

#### Tap Only Price

€413

## Kubus

### KBV 651 Glass & Mythos MTX SilkSteel tap

Practical and eye-catching, this 1½ bowl popular option offers a modern minimalist look. Available in Aqua or Black to complement many appliances. Includes pop-up waste.

\*NB: Mythos MTV tap only available with Black shoulders. Shown with optional Rollamat.

Pictured Sink 101.0052.397  
Pictured Tap 115.0049.966

3 WEEK DELIVERY



Cabinet width  
600mm

#### Finish Glass

	Aqua	LHD 101.0052.370 RHD 101.0052.388
	Black	LHD 101.0052.397 RHD 101.0052.398

Alternative  
Colour



Available at extra cost



Strainer Bowl with handles  
Stainless Steel €98  
112.0014.123

Rollamat 40  
€87  
112.0050.988

Suggested Alternative Tap  
All tap options  
on p38-49

Mythos MTV\*  
in SilkSteel  
add  
€374  
115.0051.539



Suggested WDU Upgrade  
All WDU options on p53

Franke Turbo  
WDU-500 add  
€298  
134.0049.848



Plumbing Kit  
Siphon II plumbing  
kit available  
€36  
112.0052.536

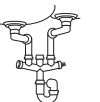

#### Sink Only Price

KBV 651  
Aqua or Black  
€1039

#### Tap Only Price

€413

# Ceramic Sinks

Classic style with a modern twist

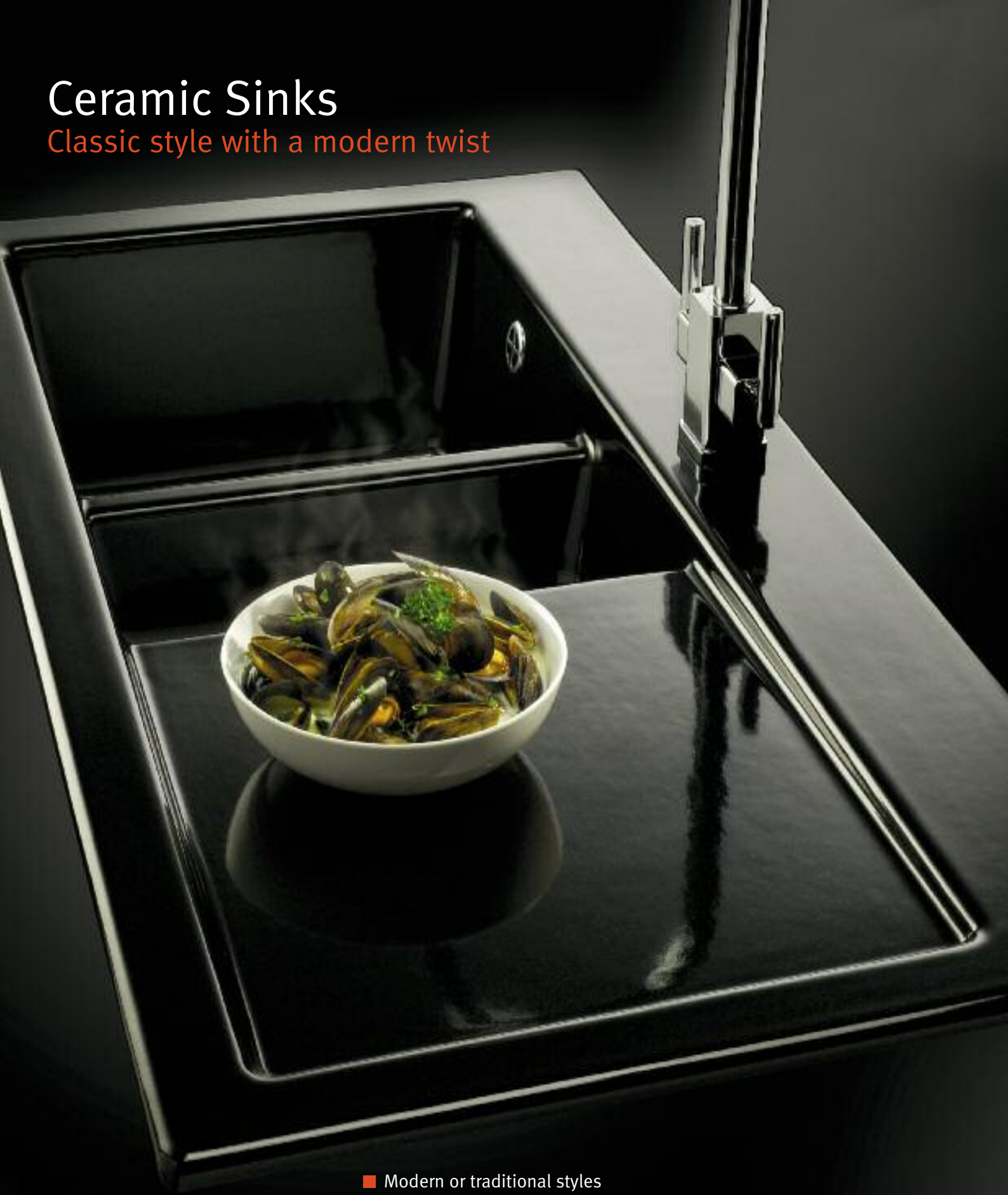

- Modern or traditional styles
- Mythos range available in white or contemporary black options
- Shown with complementary tap designs

Made from kiln-fired porcelain for a tough, smooth gloss finish able to stand up to even the harshest treatment. Franke Ceramic sinks have a fingertip-smooth high-gloss finish designed to look perfectly pristine – even after years of loyal and hard-working service.

## Mythos

### MTK 611 Ceramic & Mythos MTX Chrome tap

A practical and angular single bowl ceramic statement for your kitchen, available in white or sleek black.

Pictured Sink 124.0050.117  
Pictured Tap 115.0049.965

4 WEEK DELIVERY

Cabinet width  
600mm

Finish Ceramic

	White	LHD 124.0050.117 RHD 124.0050.118
	Black	LHD 124.0050.119 RHD 124.0050.120

Alternative  
Colour



Available at extra cost



Rollamat 38  
€87  
112.0050.989

Suggested Alternative Tap  
All tap options  
on p38-49

Mythos MTX  
in SilkSteel  
€413  
115.0049.966



Suggested WDU  
All WDU options on p53

Franke Turbo  
WDU-500  
€298  
134.0049.848



Plumbing Kit  
Siphon I plumbing  
kit available  
€24  
112.0059.946



Sink Only Price

MTK 611 - White  
€604

MTK 611 - Black  
€701

Tap Only Price

Sink and tap included  
€387

## Mythos

### MTK 651 Ceramic & Mythos MTX Chrome tap

For those preferring a one and a half bowl sink option, convert it to the lustre of white or sleek black ceramic whilst conforming to modern geometric shapes.

Shown with optional Rollamat.

Pictured Sink 124.0050.123  
Pictured Tap 115.0049.965

3 WEEK DELIVERY

Cabinet width  
600mm

Finish Ceramic

	White	LHD 124.0050.121 RHD 124.0050.122
	Black	LHD 124.0050.123 RHD 124.0050.124

Alternative  
Colour



Available at extra cost



Rollamat 38  
€87  
112.0050.989

Suggested Alternative Tap  
All tap options  
on p38-49

Mythos MTX  
in SilkSteel  
€413  
115.0049.966



Suggested WDU  
All WDU options on p53

Franke Turbo  
WDU-500  
€298  
134.0049.848



Plumbing Kit  
Siphon II plumbing  
kit available  
€36  
112.0052.536



Sink Only Price

MTK 651 - White  
€761

MTK 651 - Black  
€846

Tap Only Price

€387

## Franke by V&B

### VBK 651<sup>†</sup> Ceramic & Eiger (White Levers) Chrome tap

Naturally safe and good looking in build and style.

Pictured Sink 124.0049.872  
Pictured Tap 115.0049.991



Cabinet width  
600mm

Finish Ceramic

White LHD 124.0049.872  
RHD 124.0049.873

Ceramic Inset VBK 651 pack includes:

Basket Strainer Waste<sup>†</sup> and hand plug  
for half bowl.

<sup>†</sup>Upgrade to Titanium wastes available  
at extra cost.

Suggested Alternative Tap  
All tap options  
on p38-49



Eiger  
(White Levers)  
in SilkSteel  
€277  
115.0049.992

Suggested WDU  
All WDU options on p53

Franke Turbo  
WDU-500  
€298  
134.0049.848



Sink Only Price

VBK 651  
€813

Tap Only Price

€257

Plumbing Kit  
Siphon II plumbing  
kit available  
€36  
112.0052.536

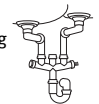

## Belfast

### BFX 710 Stainless Steel & Bridge Lever Chrome tap

A traditional style in a practical modern material.

Pictured Sink 123.0050.185  
Pictured Tap 115.0049.962



Cabinet width  
600mm

Finish

Silk 123.0050.185

Suggested Alternative Tap  
All tap options  
on p38-49



Belfast  
in Chrome  
€344  
115.0049.997

Suggested WDU  
All WDU options on p53

Franke Turbo  
WDU-500  
€298  
134.0049.848



Plumbing Kit  
Siphon I plumbing  
kit available  
€24  
112.0059.946



Sink Only Price

BFX 710  
€736

Tap Only Price

€252

## Belfast

### VBK 710 Ceramic & Bridge Gold tap

Capture traditional values in this single bowl format.

Pictured Sink 130.0049.875  
Pictured Tap 115.0049.961



Cabinet width  
600mm

Finish Ceramic

White 130.0049.875

Titanium waste and overflow



Bridge Lever tap  
also available  
Chrome  
115.0049.962  
SilkSteel  
115.0049.963  
(see page 44)

#### Suggested Alternative Tap

All tap options  
on p38-49



Belfast tap  
in Chrome  
(115.0049.997)  
€344

#### Suggested WDU

All WDU options on p53

Franke Turbo  
WDU-500  
€298  
134.0049.848



Plumbing Kit  
Siphon I plumbing  
kit available €24  
112.0059.946



#### Sink Only Price

€531

Inc. Chrome Waste and Overflow  
€53

Brass Waste and Overflow

#### Tap Only Price

€271

## Belfast

### VBK 720 Ceramic & Bridge Gold tap

Big bowls with a traditional feel.

Pictured Sink 130.0049.876  
Pictured Tap 115.0049.961



Cabinet width  
800mm

Finish Ceramic

White 130.0049.876

Titanium Basket Strainer Wastes



Bridge Lever tap  
also available  
Chrome  
115.0049.962  
SilkSteel  
115.0049.963  
(see page 44)

#### Suggested Alternative Tap

All tap options  
on p38-49



Belfast tap  
(115.0049.997)  
€344

#### Suggested WDU

All WDU options on p53

Franke Turbo  
WDU-500  
€298  
134.0049.848



Plumbing Kit  
Siphon II plumbing  
kit available €36  
112.0052.536



#### Sink Only Price

€682

Inc. Chrome Waste and Overflow  
€121

Brass Waste x2

#### Tap Only Price

€271

# Undermount Sinks

Understated sophistication



- Designed to be undermounted in solid work surfaces
- Wide variety of shapes and sizes to suit your kitchen
- Shown with complementary tap designs

Particularly pleasing when combined with solid granite, wood or solid surface worktops, undermount sinks allow for smooth, uninterrupted surface lines. These sinks are fitted underneath the worktop cut-out so that the sink edge doesn't rise above the level of the work area. Franke Undermount sinks are available in single, double and multi-bowl configurations in a wide range of shapes and sizes.

## Bolero

### BOX 160D Stainless Steel & Planar Chrome tap

An extremely practical sink with iconic good looks.

Available with left or right hand small bowl.

Pictured Sink 122.0049.818  
Pictured Tap 115.0049.999



Cabinet width  
600mm

#### Finish



Silk LHSB 122.0049.818  
RHSB 122.0049.819

Available at extra cost



Rollamat 40  
€87  
112.0050.988

**Suggested Alternative Tap**  
All tap options on p38-49

Planar in SilkSteel  
€460  
115.0050.000



**Suggested WDU**  
All WDU options on p53

Franke Turbo WDU-500  
€298  
134.0049.848



**Plumbing Kit**  
Siphon II plumbing kit available  
€36  
112.0052.536



#### Sink Only Price

BOX 160D  
€695

#### Tap Only Price

€432

## Bolero

### BOX 110 17 + BOX 110 35 Stainless Steel & Planar Chrome tap

The ultimate geometric shapes for sharp profiles in granite surfaces.

Pictured Sinks  
BOX 110 17 122.0049.817  
BOX 110 35 122.0049.815  
Pictured Tap 115.0049.999



Cabinet width  
800mm  
assumes 50mm bridge

#### Finish



Silk BOX 110 17 - 122.0049.817  
BOX 110 35 - 122.0049.815

4 WEEK DELIVERY

Available at extra cost



Rollamat 40  
€87  
112.0050.988

**Suggested Alternative Tap**  
All tap options on p38-49

Planar in SilkSteel  
€460  
115.0050.000



**Suggested WDU**  
All WDU options on p53

Franke Turbo WDU-500 add  
€298  
134.0049.848



**Plumbing Kit**  
Siphon II plumbing kit available  
€36  
112.0052.536



#### Sink Only Price

BOX 110 17  
€351  
BOX 110 35  
€383

#### Tap Only Price

€432

## UK Range

### UKX 110 45 Stainless Steel & Olympus Chrome tap

All the requirements of a horizontal bowl format.

Pictured Sink 122.0036.577  
Pictured Tap 115.0049.980



Cabinet width  
500mm

Finish



Silk 122.0036.577

Available at extra cost



Rollamat 40  
€87  
112.0050.988

#### Suggested Alternative Tap

All tap options  
on p38-49

Olympus  
Side Spray  
in Chrome  
€436

115.0051.538



#### Suggested WDU

All WDU options on p53

Franke Turbo  
WDU-500  
€298

134.0049.848



#### Plumbing Kit

Siphon I plumbing  
kit available  
€24

112.0059.946

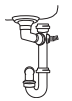

#### Sink Only Price

UKX 110 45  
€270

#### Tap Only Price

€290

## Largo

### LAX 110 45 Stainless Steel & Olympus Chrome tap

A jumbo bowl that still fits into a  
500mm format cabinet.†

Pictured Sink 122.0066.736  
Pictured Tap 115.0049.980



Cabinet width  
500mm†

Finish



Silk 122.0066.736

Available at extra cost



Rollamat 40  
€87  
112.0050.988

#### Suggested Alternative Tap

All tap options  
on p38-49

Olympus  
Side Spray  
in Chrome  
€436

115.0051.538



#### Suggested WDU

All WDU options on p53

Franke Turbo  
WDU-500  
€298

134.0049.848



#### Plumbing Kit

Siphon I plumbing  
kit available  
€24

112.0059.946



#### Sink Only Price

LAX 110 45  
€277

#### Tap Only Price

€290



## Largo

### LAX 110 50 Stainless Steel & Olympus Chrome tap

Giant bowl for those with a desire to maximise space.

Pictured Sink 122.0035.334  
Pictured Tap 115.0049.980



Cabinet width  
600mm

#### Finish



Silk 122.0035.334

Available at extra cost



Rollamat 40  
€87  
112.0050.988

**Suggested Alternative Tap**  
All tap options  
on p38-49

Olympus  
Side Spray  
in Chrome  
€436  
115.0051.538



**Suggested WDU**  
All WDU options on p53

Franke Turbo  
WDU-500  
€298  
134.0049.848



**Plumbing Kit**  
Siphon I plumbing  
kit available  
€24  
112.0059.946



#### Sink Only Price

LAX 110 50  
€290

#### Tap Only Price

€290

## Oceana

### OAX 110\* Stainless Steel & Olympus Chrome tap\*

A truly mammoth sized bowl for the largest of families.

\*Worktop depth should be 650mm.

Pictured Sink 122.0052.085  
Pictured Tap 115.0049.980



Cabinet width  
800mm

#### Finish



Silk 122.0052.085

Available at extra cost



Rollamat 40  
€87  
112.0050.988

**Suggested Alternative Tap**  
All tap options  
on p38-49

Olympus  
Side Spray  
in Chrome  
€436  
115.0051.538



**Suggested WDU**  
All WDU options on p53

Franke Turbo  
WDU-500  
€298  
134.0049.848



**Plumbing Kit**  
Siphon I plumbing  
kit available  
€24  
112.0059.946



#### Sink Only Price

OAX 110  
€595

#### Tap Only Price

OAX 110  
€290

## Ariane

### ARX 160 Stainless Steel & Olympus Chrome tap\*

The best selling combination of bowl and a half formats.

Available with left or right hand small bowl.

Pictured Sink 122.0040.304  
Pictured Tap 115.0049.980



Cabinet width 600mm

#### Finish

 Silk LHSB 122.0040.304  
RHSB 122.0040.305

Available at extra cost



#### Suggested Alternative Tap

All tap options on p38-49

Olympus Side Spray in Chrome  
€436

115.0051.538



#### Suggested WDU

All WDU options on p53

Franke Turbo WDU-500  
€298

134.0049.848



#### Plumbing Kit

Siphon II plumbing kit available  
€36

112.0052.536



#### Sink Only Price

ARX 160  
€483

#### Tap Only Price

€290

## Ariane

### ARX 160D Stainless Steel & Olympus Chrome tap\*

Symmetrical lines in a pleasing bowl and a half configuration.

Available with left or right hand small bowl.

Pictured Sink 122.0040.388  
Pictured Tap 115.0049.980



Cabinet width 600mm

#### Finish

 Silk LHSB 122.0040.388  
RHSB 122.0040.389

Available at extra cost



#### Suggested Alternative Tap

All tap options on p38-49

Olympus Side Spray in Chrome  
€436

115.0051.538



#### Suggested WDU

All WDU options on p53

Franke Turbo WDU-500  
€298

134.0049.848



#### Plumbing Kit

Siphon II plumbing kit available  
€36

112.0052.536



#### Sink Only Price

ARX 160D  
€553

#### Tap Only Price

€290

## Galassia

### GAX 120 Stainless Steel & Olympus Chrome tap\*

A large double bowl combination.

NB. Only available with right hand small bowl.

Pictured Sink 122.0021.417  
Pictured Tap 115.0049.980



Cabinet width  
900mm

Finish



Silk 122.0021.417

Available at extra cost



Drainer Basket  
S/Steel €152  
112.0050.241



Rollamat 40  
€87  
112.0050.988

Suggested Alternative Tap  
All tap options  
on p38-49

Olympus  
Side Spray  
in Chrome  
€436  
115.0051.538



Suggested WDU  
All WDU options on p53

Franke Turbo  
WDU-500  
€298  
134.0049.848



Plumbing Kit  
Siphon II plumbing  
kit available  
€36  
112.0052.536



Sink Only Price

GAX 120  
€548

Tap Only Price

€290

## Regatta

### RGX 120\* Stainless Steel & Olympus Chrome tap\*

Jumbo bowls in one cut-out.

\*Worktop depth should be 650mm.

Pictured Sink 122.0032.918  
Pictured Tap 115.0049.980



Cabinet width  
1000mm

Finish



Silk 122.0032.918

Available at extra cost



Rollamat 40  
€87  
112.0050.988

Suggested Alternative Tap  
All tap options  
on p38-49

Olympus  
Side Spray  
in Chrome  
€436  
115.0051.538



Suggested WDU  
All WDU options on p53

Franke Turbo  
WDU-500  
€298  
134.0049.848



Plumbing Kit  
Siphon II plumbing  
kit available  
€36  
112.0052.536



Sink Only Price

RGX 120  
€583

Tap Only Price

€290

## Beach

### BBX 160 Stainless Steel\* & Olympus Chrome tap

The undermount version of this revolutionary design. Includes twin pop-up waste.

\*Important: Worktop thickness must be between 28-32mm to ensure correct functioning of sink and accessories. NB. Pop up knob only available in Chrome finish.

Pictured Sink 122.0039.772  
Pictured Tap 115.0049.980

Cabinet width  
600mm

#### Finish

 Silk 122.0039.772



3 WEEK DELIVERY

Beach BBX 160 sink includes†:



Lock-in Bowl  
Stainless Steel  
122.0006.075



Measuring Bowl  
Stainless Steel  
122.0006.073



Colander  
Stainless Steel  
122.0006.074

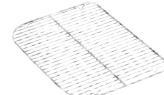

Grille  
Stainless steel  
122.0007.572



Food  
Preparation Platter  
122.0007.578

Suggested Alternative Tap  
All tap options  
on p38-49

Fuji  
Pull-out Nozzle  
in Chrome  
€321  
115.0049.987



Suggested WDU  
All WDU options on p53

Franke Turbo  
WDU-500  
€298  
134.0049.848



Plumbing Kit  
Siphon II plumbing  
kit available  
€36  
112.0052.536

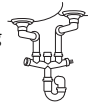

Sink Only Price†

BBX 160  
€795

Tap Only Price

€290

## Kubus

### KBX 160 34-16 Stainless Steel & Kubus Chrome tap\*

Combining practicality with modern minimalistic design whilst fitting into a 600mm base unit.

Available with left or right hand small bowl.

Pictured Sink 122.0033.122  
Pictured Tap 115.0050.008

Cabinet width  
600mm

#### Finish

 Silk LHSB 122.0033.122  
RHSB 122.0033.137



Available at extra cost



Strainer Bowl with  
handles S/Steel €98  
112.0014.122

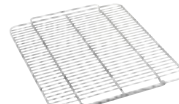

Drainer Grille  
S/Steel €39  
112.0014.121



Bread Board/ Food  
Preparation Platter €78  
112.0050.270

Suggested Alternative Tap  
All tap options  
on p38-49

Mythos MTX  
in Chrome  
€387  
115.0049.965



Suggested WDU  
All WDU options on p53

Franke Turbo  
WDU-500  
€298  
134.0049.848



Plumbing Kit  
Siphon II plumbing  
kit available  
€36  
112.0052.536

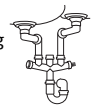

Tap Only Price

KBX 160 34-16  
€595

Tap Only Price

€322

## Kubus

### KBX 160 45-20 Stainless Steel & Kubus Chrome tap\*

Optimisation of bowl sizes in an attractive framework.

Available with left or right hand small bowl.

Pictured Sink 122.0033.140  
Pictured Tap 115.0050.008

Cabinet width  
800mm

#### Finish



Silk LHSB 122.0033.140  
RHSB 122.0033.141



Available at extra cost



Strainer Bowl with handles S/Steel €98  
112.0014.123



Drainer Grille S/Steel €39  
112.0014.121



Food Preparation Platter Wood/Iroko €65  
112.0014.124



Bread Board/ Food Preparation Platter €77  
112.0050.270

#### Suggested Alternative Tap

All tap options on p38-49

Mythos MTX in Chrome  
€387  
115.0049.965



#### Suggested WDU

All WDU options on p53

Franke Turbo WDU-500  
€298  
134.0049.848



Plumbing Kit Siphon II plumbing kit available  
€36  
112.0052.536



#### Sink Only Price

KBX 160 45-20  
€527

#### Tap Only Price

€322

## Kubus

### KBX 120 34-34 Stainless Steel & Kubus Chrome tap\*

Practicality meets minimalism with sleek, uninterrupted lines. This sink offers two large, identically sized bowls for a pleasing symmetry.

Pictured Sink 122.0061.524  
Pictured Tap 115.0050.008

3 WEEK DELIVERY

Cabinet width  
900mm

#### Finish



Silk 122.0061.524



Available at extra cost



Strainer Bowl with handles S/Steel €98  
112.0014.123

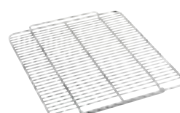

Drainer Grille S/Steel €39  
112.0014.121



Food Preparation Platter Wood/Iroko €66  
112.0014.124



Bread Board/ Food Preparation Platter €78  
112.0050.270

#### Suggested Alternative Tap

All tap options on p38-49

Mythos MTX in Chrome  
€387  
115.0049.965



#### Suggested WDU

All WDU options on p53

Franke Turbo WDU-500  
€298  
134.0049.848



Plumbing Kit Siphon II plumbing kit available  
€36  
112.0052.536



#### Sink Only Price

KBX 120 34-34  
€629

#### Tap Only Price

€322

## Kubus

### KBG 160 Fraganite & Kubus Chrome tap

All the benefits of modern design wrapped up in one cut out in Fraganite material.

NB: Only available with right hand small bowl.†Mythos MTG tap available with Graphite or Polar White shoulders.

Pictured Sink 125.0046.877  
Pictured Tap 115.0050.008

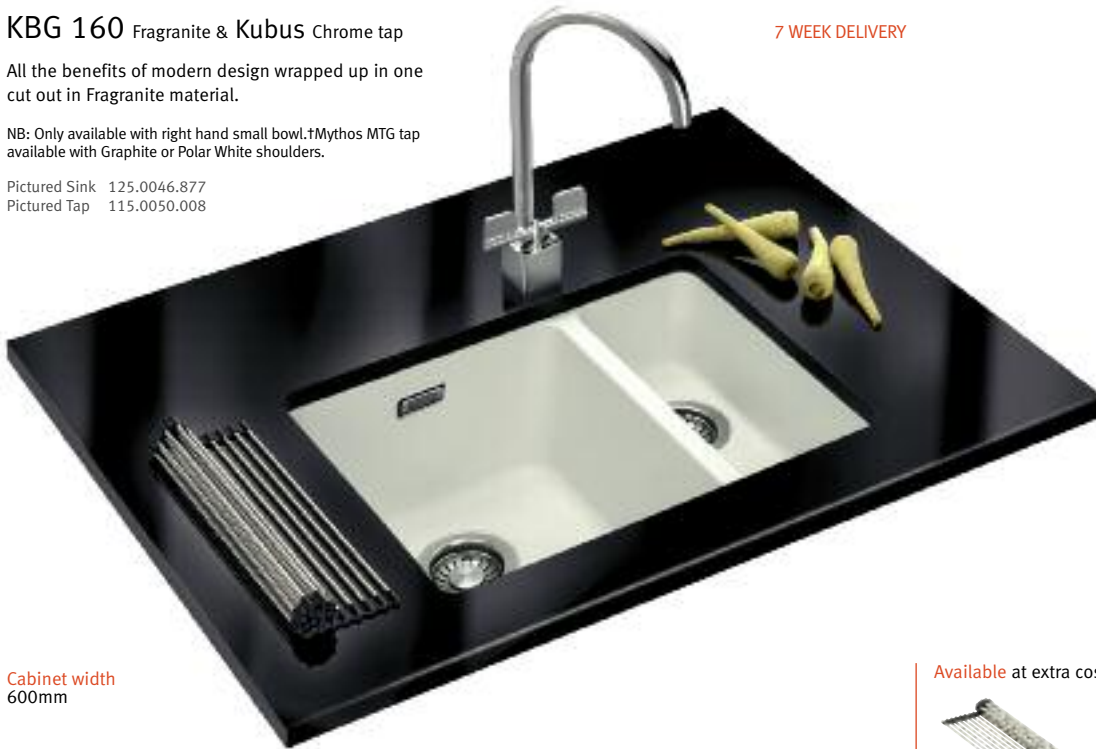

7 WEEK DELIVERY

Cabinet width  
600mm

Finish SilkSheen

	Polar White	125.0046.877
	Graphite	125.0046.878

Available at extra cost



Rollamat 40  
€87  
112.0050.988

#### Suggested Alternative Tap

All tap options  
on p38-49

Mythos MTG  
Polar White†  
in Chrome  
€387

115.0049.969



#### Suggested WDU

All WDU options on p53

Franke Turbo  
WDU-500  
€298

134.0049.848



#### Plumbing Kit

Siphon II plumbing  
kit available  
€36

112.0052.536

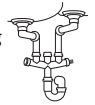

#### Sink Only Price

KBG 160  
€465

#### Tap Only Price

€322

## Kubus

### KBG 110 16 + KBG 110 34 Fraganite & Kubus Chrome tap

Combinations of Fraganite bowls provide solutions for design requirements.

† Mythos MTG tap available with Graphite or Polar White shoulders.

Pictured Sink  
KBG 110 16 125.0046.870  
KBG 110 34 125.0046.872  
Pictured Tap 115.0050.008



7 WEEK DELIVERY

Cabinet width  
600mm  
assumes 50mm bridge

Finish SilkSheen

	Polar White	KBG 110 16 - 125.0046.869 KBG 110 34 - 125.0046.871
	Graphite	KBG 110 16 - 125.0046.870 KBG 110 34 - 125.0046.872

Available at extra cost



Rollamat 40  
€87  
112.0050.988

#### Suggested Alternative Tap

All tap options  
on p38-49

Mythos MTG  
Graphite†  
in Chrome  
€387

115.0049.967



#### Suggested WDU

All WDU options on p53

Franke Turbo  
WDU-500  
€298

134.0049.848



#### Plumbing Kit

Siphon II plumbing  
kit available  
€36

112.0052.536

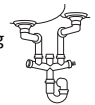

#### Sink Only Price

KBG 110 16  
€244

KBG 110 34  
€348

#### Tap Only Price

€322

## Kubus

KBG 110 16 + KBG 110 50 Fraganite & Kubus Chrome tap

7 WEEK DELIVERY

Little and large combinations provide optimum sizes for functional kitchens.

† Mythos MTG tap available with Graphite or Polar White shoulders.

Pictured Sink  
 KBG 110 16 125.0046.870  
 KBG 110 50 125.0046.875  
 Pictured Tap 115.0050.008

Cabinet width  
 800mm  
 assumes 50mm bridge

Finish SilkSheen

	Polar White	KBG 110 16 - 125.0046.869 KBG 110 50 - 125.0046.874
	Graphite	KBG 110.16 - 125.0046.870 KBG 110 50 - 125.0046.875



Available at extra cost



Rollamat 40  
 €87  
 112.0050.988

Suggested Alternative Tap  
 All tap options  
 on p38-49

Mythos MTG  
 Graphite†  
 in Chrome  
 €387  
 115.0049.967



Suggested WDU  
 All WDU options on p53

Franke Turbo  
 WDU-500  
 €298  
 134.0049.848



Plumbing Kit  
 Siphon II plumbing  
 kit available  
 €36  
 112.0052.536

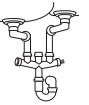

### Sink Only Price

KBG 110 16  
 €244

KBG 110 50  
 €387

### Tap Only Price

€322

## Rotondo

RUX 110 Stainless Steel & Olympus Chrome tap\*

A round solution where space is at a premium or in corner situations.

Pictured Sink 127.0050.183  
 Pictured Tap 115.0049.980

Cabinet width  
 500mm

Finish

	Brushed	127.0050.183
---	---------	--------------



Available at extra cost



Drainer Basket  
 White €45  
 112.0050.254



Drainer Basket  
 S/Steel €152  
 112.0050.639



RBX Food Preparation  
 Platter Wood/Iroko  
 €65  
 112.0018.187



Rollamat 40  
 €87  
 112.0050.988

Suggested Alternative Tap  
 All tap options  
 on p38-49

Olympus  
 Side Spray  
 in Chrome  
 €436  
 115.0051.538



Suggested WDU  
 All WDU options on p53

Franke Turbo  
 WDU-500  
 €298  
 134.0049.848



Plumbing Kit  
 Siphon I plumbing  
 kit available  
 €24  
 112.0059.946



### Sink Only Price

RUX 110  
 €298

### Tap Only Price

€290

## Rotondo

### RUK 110 Ceramic & Olympus Chrome tap

Natural materials providing the ultimate option for practicality and space. Now also available in sleek black.

Pictured Sink 126.0066.527  
Pictured Tap 115.0049.980

4 WEEK DELIVERY



Cabinet width  
500mm

#### Finish

	White	126.0050.125
	Black	126.0066.527



Alternative Colour

Available at extra cost



Drainer Basket  
S/Steel €153  
112.0050.639



Rollamat 40  
€87  
112.0050.988

#### Suggested Alternative Tap

All tap options  
on p38-49



Belfast  
in Chrome  
€344  
115.0049.997

#### Suggested WDU

All WDU options on p53



Franke Turbo  
WDU-500  
€298  
134.0049.848

#### Plumbing Kit Siphon I plumbing kit available

€24  
112.0059.946



#### Sink Only Price

RUK 110 - White

€483

NEW RUK 110 - Black

€483

#### Tap Only Price

€290

## Franke by V&B

### VBK 110 21 + VBK 110 33 Ceramic & Eiger (White Levers) Chrome tap

A combination of lustrous white ceramic bowls. Also available in sleek black.

NB. VBK 110 21 & VBK 110 33 cannot be fitted with a reveal due to unglazed flange.

Pictured Sink  
VBK 110 21 126.0066.541  
VBK 110 33 126.0066.547  
Pictured Tap 115.0049.991



Cabinet width  
800mm  
assumes 70mm bridge

#### Finish

	White	VBK 110 21 - 126.0066.541 VBK 110 33 - 126.0066.547
	Black	VBK 110 21 - 126.0066.542 VBK 110 33 - 126.0066.550



Alternative Colour

Available at extra cost



Rollamat 40  
€87  
112.0050.988

#### Suggested Alternative Tap

All tap options  
on p38-49



Gotthard  
(White Lever)  
in Chrome  
€306  
115.0049.995

#### Suggested WDU

All WDU options on p53



Franke Turbo  
WDU-500  
€298  
134.0049.848

#### Plumbing Kit Siphon II plumbing kit available

€36  
112.0052.536



#### Sink Only Price

VBK 110 21  
White

€278

VBK 110 33  
White

€368

VBK 110 21  
Black

€368

VBK 110 33  
Black

€465

#### Tap Only Price

€257



## Franke by V&B

### VBK 160 Ceramic & Eiger Chrome tap

Ceramic bowls converted into an undermount statement.  
45mm waste and hand plug supplied in half bowl.  
Now also available in sleek black.



NB. Only available with left hand small bowl.  
VBK 160 cannot be fitted with a reveal due to unglazed flange.

Pictured Sink 126.0066.532  
Pictured Tap 115.0049.989



Cabinet width  
600mm

#### Finish

	White	126.0050.115
	Black	126.0066.532

Available at extra cost



Rollamat 40  
€87  
112.0050.988

#### Suggested Alternative Tap

All tap options  
on p38-49

Fuji  
in Chrome  
€270  
115.0049.985



#### Suggested WDU

All WDU options on p53

Franke Turbo  
WDU-500  
€298  
134.0049.848



Plumbing Kit  
Siphon II plumbing  
kit available  
€36  
112.0052.536



#### Sink Only Price

VBK 160 - White  
€681  
NEW VBK 160 - Black  
€604

#### Tap Only Price

€257

# Undermounted Installation Guide

## Installing your undermount sink

A template and fixing clips are provided in the sink box. Some circumstances may allow for fitting a bowl directly to the worktop. We would recommend the use of a sealant between the flange of the sink and the worktop to avoid any water ingress. In all cases you are advised to consult your supplier.



Alternative fixing systems



Templates provided

\*VBK 160, VBK 110 21 & VBK 110 33 cannot be fitted with a reveal due to unglazed flange.

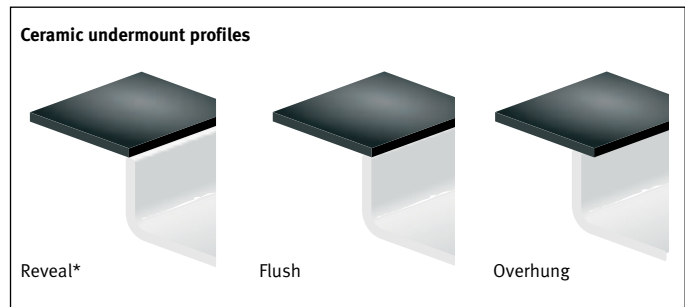
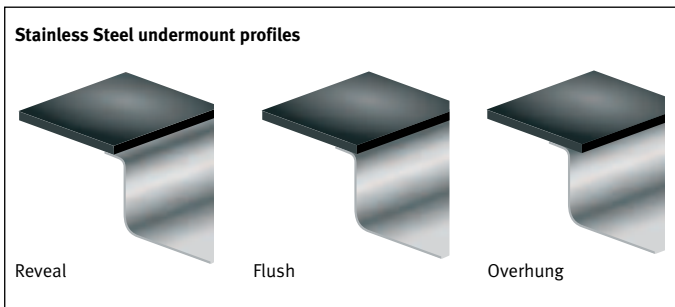

## Franke G-Clip

### The next-generation installation system

The new patented Franke G-Clip system is a revolution in the installation of undermounted sinks, with considerable time savings. With this system you will see no visible difference from traditional fixing methods, whilst gaining the benefits of less installation time and effort required.



The innovative technology distributes weight from the sink bowl laterally through the use of simple metal clamps that can be fitted in minutes and are strong enough to withstand more than a 100kg weight. The application of sealant ensures a watertight seal, with the G-Clip system firmly holding the sink in place.

G-Clips can easily be removed with a simple tap from a hammer. For more information and demonstration video visit [www.franke.co.uk/gclip](http://www.franke.co.uk/gclip)



## Franke Rollamat

Truly versatile, the Franke Rollamat is an essential accessory for every kitchen

This multi-purpose item can help protect sink and kitchen surfaces and is extremely useful for hot pans, heavy objects and for defrosting food items. It also provides the ideal draining surface for modern flat draining areas on minimalist sinks and can be easily rolled up and conveniently stored away after use. This flexible little helper is dishwasher safe and will be a welcome addition to any hardworking kitchen. The Franke Rollamat is available in two sizes:

<b>Rollamat 38</b>	112.0050.989	
383 x 344mm (Mythos MTK only)		€87
<b>Rollamat 40</b>	112.0050.988	
400 x 400mm		€87



Protects surfaces from hot pans and heavy objects.



Ideal draining surface for minimalist sinks.

## Plumbing Kits

The perfect plumbing solution

Made of rigid grey polypropylene, these plumbing kits are the hygienic solution to a Franke sink waste system. Some sinks in this brochure require a plumbing kit to be purchased separately. The plumbing kits recommended within this brochure are shown below.

**Siphon I** 112.0059.946  
for a single bowl sink €24

**Siphon II** 112.0052.536  
for a 1½ bowl sink €36



## Specialist Tap Range

A comprehensive selection of precision made taps to complement any Franke sink

Featuring the innovative pull-out Rolux tap with LED lights, the Franke Specialist Tap Range is a technically and aesthetically advanced collection. Including the angular style of Ticino, classically rounded Basel and – for the first time – two solid stainless steel designs in Panto and Eos to perfectly complement your choice of sink.

Finish

Chrome €725  
115.0068.025

Tap Brace

The patented innovative Franke Tap Brace can be fitted to any tap to avoid flexing of stainless steel sinks.



€23  
133.0026.896



Rolux Pull-out Spray

(1) 4 P Pictured Tap 115.0068.025



Base diameter 52mm  
Tap cut-out 35mm

Panto

(1) 6 P Pictured Tap 115.0063.559

Stainless Steel €265  
115.0063.559



Base diameter 54mm  
Tap cut-out 35mm

Eos

(1) 5 P Pictured Tap 115.0063.568

Stainless Steel €277  
115.0063.568



Base diameter 54mm  
Tap cut-out 35mm

Ticino

(1) 5 P Pictured Tap 115.0068.026

Chrome €471  
115.0068.026  
SilkSteel €519  
115.0068.027



Base diameter 58 x 48mm  
Tap cut-out 35mm

Basel

(1) 6 P Pictured Tap 115.0068.028

Chrome €216  
115.0068.028  
SilkSteel €241  
115.0068.029



Available Spring 09

Base diameter 52mm  
Tap cut-out 35mm

(1) Ceramic disc tap – may require a 4 metre head of water in a conventional plumbing system. (2) Compression valve tap – usually suitable for any plumbing system. In some instances, pull-out nozzle and spray taps may require additional pumping or local authority approval prior to installation.

Franke strongly recommends that you consult your supplier/installer prior to purchase.

1 The figure in the symbol is designed to indicate the relative flow rate performance for each tap. The rate is graded 1-8 where 1 is poor and 8 is excellent. Relative flow rates are only likely to be relevant in installations with a low head of water (below 4 metres) or low cold supply pressure. In either case you would be well advised to consult your supplier or installer.



All Franke taps are designed to conform to Water Research Council requirements and are backed by nationwide servicing and guarantees.

P Indicates tap is fitted with a Perlator® providing a champagne-like flow.  
All prices inclusive of V.A.T @ 21%

### Mythos MTX

(1)  Pictured Tap 115.0049.965



Finish	
	Chrome €387 115.0049.965
	SilkSteel €413 115.0049.966



Base diameter 46mm  
Tap cut-out 35mm

3 WEEK DELIVERY

### Mythos MTG

(1)  Pictured Tap 115.0049.967



Finish	
	Chrome €387 Graphite shoulders 115.0049.967 White shoulders 115.0049.969
	SilkSteel €413 Graphite shoulders 115.0049.968 White shoulders 115.0049.970

NB: Available with Graphite or White shoulders

Base diameter 46mm  
Tap cut-out 35mm

### Mythos MTV

(1)  Pictured Tap 115.0051.536



	Chrome €359 115.0051.536
	SilkSteel €374 115.0051.539

MTV Tap available with Black shoulders only.  
3 WEEK DELIVERY

Base diameter 46mm  
Tap cut-out 35mm

### Mythos Pull-out Nozzle

(1)  Pictured Tap 115.0049.964



	SilkSteel €515 115.0049.964
---	--------------------------------

3 WEEK DELIVERY



Base diameter 57mm  
Tap cut-out 35mm

### Davos 'J'

(1)  Pictured Tap 115.0050.044



	Chrome €185 115.0050.044
	SilkSteel €215 115.0049.940

Base diameter 55mm  
Tap cut-out 35mm

### Davos

(1)  Pictured Tap 115.0046.694



	Chrome €185 115.0046.694
	SilkSteel €215 115.0046.695

Base diameter 48mm  
Tap cut-out 35mm

(1) Ceramic disc tap – may require a 4 metre head of water in a conventional plumbing system. (2) Compression valve tap – usually suitable for any plumbing system. In some instances, pull-out nozzle and spray taps may require additional pumping or local authority approval prior to installation.

Franke strongly recommends that you consult your supplier/installer prior to purchase.

 The figure in the symbol is designed to indicate the relative flow rate performance for each tap. The rate is graded 1-8 where 1 is poor and 8 is excellent. Relative flow rates are only likely to be relevant in installations with a low head of water (below 4 metres) or low cold supply pressure. In either case you would be well advised to consult your supplier or installer.

All Franke taps are designed to conform to Water Research Council requirements and are backed by nationwide servicing and guarantees.

 Indicates tap is fitted with a Perlator® providing a champagne-like flow.

All prices inclusive of V.A.T. @ 21%

### Olympus

(1) Pictured Tap 115.0049.980



Finish	
	Chrome €290 115.0049.980
	SilkSteel €307 115.0049.979

Base diameter 60mm  
Tap cut-out 35mm

### Olympus U-Spout

(1) Pictured Tap 115.0051.544



Finish	
	Chrome €280 115.0051.544
	SilkSteel €299 115.0051.545

Base diameter 60mm  
Tap cut-out 35mm

### Olympus Side Spray

(1) Pictured Tap 115.0051.538



	Chrome €436 115.0051.538
--	-----------------------------

NB. Cold spray only  
Rinse cannot be fitted retrospectively to standard Olympus model.



Tap base diameter 60mm  
Tap cut-out 35mm  
Spray base diameter 50mm  
Spray cut-out 30mm  
Max depth worktop 57mm

### Rotaflow

(2) Pictured Tap 115.0049.949



	Chrome €145 115.0049.950
	SilkSteel €162 115.0049.949

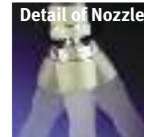

Base diameter 45mm  
Tap cut-out 35mm

### Orca

(1) Pictured Tap 115.0050.002



	Chrome €352 115.0050.002
	SilkSteel €396 115.0050.003

3 WEEK DELIVERY

Base diameter 52mm  
Tap cut-out 35mm

### Orca Spray Pull-out Spray

(1) Pictured Tap 115.0050.004



	Chrome €417 115.0050.004
	SilkSteel £462 115.0050.005

3 WEEK DELIVERY



Base diameter 52mm  
Tap cut-out 35mm

(1) Ceramic disc tap – may require a 4 metre head of water in a conventional plumbing system. (2) Compression valve tap – usually suitable for any plumbing system. In some instances, pull-out nozzle and spray taps may require additional pumping or local authority approval prior to installation.

Franke strongly recommends that you consult your supplier/installer prior to purchase.

The figure in the symbol is designed to indicate the relative flow rate performance for each tap. The rate is graded 1-8 where 1 is poor and 8 is excellent. Relative flow rates are only likely to be relevant in installations with a low head of water (below 4 metres) or low cold supply pressure. In either case you would be well advised to consult your supplier or installer.

All Franke taps are designed to conform to Water Research Council requirements and are backed by nationwide servicing and guarantees.

Indicates tap is fitted with a Perlator® providing a champagne-like flow.

All prices inclusive of V.A.T @ 21%

Eiger

(1) Pictured Tap 115.0049.989



Finish	
	Chrome 115.0049.989 €257
	SilkSteel 115.0049.990 €277

Base diameter 55mm  
Tap cut-out 35mm

4 WEEK DELIVERY

Gotthard (White Lever)

(1) Pictured Tap 115.0049.995



	Chrome 115.0049.995 €306
	SilkSteel 115.0049.996 €322

Base diameter 55mm  
Tap cut-out 35mm

Fuji Pull-out Nozzle

(1) Pictured Tap 115.0049.988

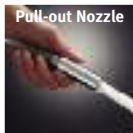

	Chrome 115.0049.987 €321
	SilkSteel 115.0049.988 €344

NB. Nozzle  
Pull-out max  
400mm

Base diameter 60mm  
Tap cut-out 35mm

Gotthard

(1) Pictured Tap 115.0049.993



Finish	
	Chrome 115.0049.993 €277
	SilkSteel 115.0049.994 €293

3 WEEK DELIVERY

Base diameter 55mm  
Tap cut-out 35mm

3 WEEK DELIVERY

Fuji

(1) Pictured Tap 115.0049.985



	Chrome 115.0049.985 €270
	SilkSteel 115.0049.986 €290

Base diameter 60mm  
Tap cut-out 35mm

Belfast

Pull-out Nozzle

(1) Pictured Tap 115.0049.997



	Chrome 115.0049.997 €321
	SilkSteel 115.0049.998 €379

3 WEEK DELIVERY

Base diameter 50mm  
Tap cut-out 35mm

(1) Ceramic disc tap – may require a 4 metre head of water in a conventional plumbing system. (2) Compression valve tap – usually suitable for any plumbing system. In some instances, pull-out nozzle and spray taps may require additional pumping or local authority approval prior to installation.

Franke strongly recommends that you consult your supplier/installer prior to purchase.

The figure in the symbol is designed to indicate the relative flow rate performance for each tap. The rate is graded 1-8 where 1 is poor and 8 is excellent. Relative flow rates are only likely to be relevant in installations with a low head of water (below 4 metres) or low cold supply pressure. In either case you would be well advised to consult your supplier or installer.

All Franke taps are designed to conform to Water Research Council requirements and are backed by nationwide servicing and guarantees.

Indicates tap is fitted with a Perlator® providing a champagne-like flow.

Retro fit white lever options are available for the Eiger and Gotthard taps.

All prices inclusive of V.A.T @ 21%

Eiger option:  
Chrome 133.0050.711  
SilkSteel 133.0050.713

Gotthard option:  
Chrome 133.0050.709  
SilkSteel 133.0050.710



3 WEEK DELIVERY

Pilatus

(1) Pictured Tap 115.0049.971



Finish	
	Chrome €494 115.0049.971
	SilkSteel €547 115.0049.972

4 WEEK DELIVERY

Base diameter 50mm  
Tap cut-out 35mm

3 WEEK DELIVERY

Pilatus PowerStream  
Pull-out Spray

(1) Pictured Tap 115.0049.974

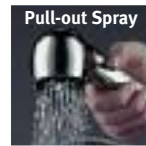

Finish	
	Chrome €547 115.0049.973
	SilkSteel €611 115.0049.974

4 WEEK DELIVERY

Base diameter 50mm  
Tap cut-out 35mm

Bridge

(2) Pictured Tap 115.0049.960



	Chrome €252 115.0049.960
	Gold €271 115.0049.961

Base diameter N/A  
Requires tap holes 25mm  
Centres min 125  
max 235

Bridge Lever

(1) Pictured Tap 115.0049.962



	Chrome €252 115.0049.962
	SilkSteel €271 115.0049.963

Base diameter N/A  
Requires tap holes 25mm  
Centres min 125  
max 235

Planar

(1) Pictured Tap 115.0049.999



	Chrome €432 115.0049.999
	SilkSteel £460 115.0050.000

Base diameter 44mm  
Tap cut-out 35mm

Swiss Pro  
Pull-out Spray

(1) Pictured Tap 115.0050.001



	Chrome €693 115.0050.001
--	-----------------------------

3 WEEK DELIVERY

Base diameter 50mm  
Tap cut-out 35mm

(1) Ceramic disc tap – may require a 4 metre head of water in a conventional plumbing system. (2) Compression valve tap – usually suitable for any plumbing system. In some instances, pull-out nozzle and spray taps may require additional pumping or local authority approval prior to installation.

Frankie strongly recommends that you consult your supplier/installer prior to purchase.

The figure in the symbol is designed to indicate the relative flow rate performance for each tap. The rate is graded 1-8 where 1 is poor and 8 is excellent. Relative flow rates are only likely to be relevant in installations with a low head of water (below 4 metres) or low cold supply pressure. In either case you would be well advised to consult your supplier or installer.

All Franke taps are designed to conform to Water Research Council requirements and are backed by nationwide servicing and guarantees.

Indicates tap is fitted with a Perlator® providing a champagne-like flow.

All prices inclusive of V.A.T @ 21%

## Franke Triflow

The patented Franke Triflow delivers water in separate channels – dispensing hot, cold, mixed or filtered.

Combining the considered beauty of our most stylish designs and the technologically advanced ceramic water filtration system of the Franke Triflow family, the products in the Franke Specialist range are the perfect addition to any modern kitchen.

These desirable taps are a stunning complement to many of the Franke sinks in the range, creating a coordinated look with effortless style. The Franke Triflow taps in the Specialist range deliver hot, cold and filtered water using an advanced ceramic cartridge. This water filtration system is protected by a robust stainless steel housing on all Specialist Franke Triflow taps, adding reassuring durability to elegant aesthetics.

Franke Triflow System Diagram





Franke Triflow Tradition SilkSteel tap



### Franke Triflow Kubus

(1)  Pictured Tap 120.0050.032

Finish	
	Chrome €776 120.0050.032
	SilkSteel €840 120.0050.033





Stainless steel filter housing



Base diameter 47mm  
Tap cut-out 35mm

### Franke Triflow Olympus

(1)  Pictured Tap 120.0050.036

Finish	
	Chrome €776 120.0050.036
	SilkSteel €840 120.0050.037





Stainless steel filter housing



Base diameter 53mm  
Tap cut-out 35mm

### Franke Triflow Doric

(1)  Pictured Tap 120.0050.026

	Chrome €822 120.0050.026
	SilkSteel €854 120.0050.028

3 WEEK DELIVERY





Stainless steel filter housing



Base diameter 60mm  
Tap cut-out 35mm

### Franke Triflow Corinthian

(1)  Pictured Tap 120.0050.024

	Chrome €757 120.0050.020
---	-----------------------------

3 WEEK DELIVERY



Stainless steel filter housing



Base diameter 60mm  
Tap cut-out 35mm

### Franke Triflow Tradition

(1)  Pictured Tap 120.0050.018

	Chrome €757 120.0050.014
	SilkSteel €807 120.0050.018
	Nickel €807 120.0050.016
	Nickel & Gold €807 120.0050.017

3 WEEK DELIVERY





Stainless steel filter housing



Base diameter 60mm  
Tap cut-out 35mm

### Franke Triflow Mini

(1)  Pictured Tap 120.0050.040

	Chrome €248 120.0050.040
	SilkSteel €298 120.0050.042

3 WEEK DELIVERY



Stainless steel filter housing



Base diameter 38mm  
Tap cut-out 12mm

(1) Ceramic disc tap – may require a 4 metre head of water in a conventional plumbing system. In some instances, pull-out nozzle and spray taps may require additional pumping or local authority approval prior to installation.

Franke strongly recommends that you consult your supplier/installer prior to purchase.

 The figure in the symbol is designed to indicate the relative flow rate performance for each tap. The rate is graded 1-8 where 1 is poor and 8 is excellent. Relative flow rates are only likely to be relevant in installations with a low head of water (below 4 metres) or low cold supply pressure. In either case you would be well advised to consult your supplier or installer.

All Franke taps are designed to conform to Water Research Council requirements and are backed by nationwide servicing and guarantees.

Franke\* Triflow\*\* are registered trademarks of \*Franke and \*\*Triflow Concepts Ltd respectively.

All prices inclusive of V.A.T @ 21%

## Franke Trispray

All the superb benefits of Franke Triflow with an added feature, the Franke Trispray system is for kitchens that demand that little bit more.

The precision engineered taps of the Franke Trispray range boast the full complement of features that are present in the Franke Triflow range – including its advanced water filtration system – but also offers an additional side spray which is usually fitted into a solid surface worktop, up to one metre away from the tap.

The ideal hygienic kitchen solution, the spray is perfect for rinsing food as part of meal preparation and dispenses hot, cold or mixed water from the main supply. Each spray is also specifically designed to reflect the aesthetic of the particular tap that it accompanies.

NB. Hand rinse cannot be fitted retrospectively to standard Franke Triflow models.

Franke Trispray Tradition Chrome tap



3 WEEK DELIVERY

### Franke Trispray Olympus

(1) Pictured Tap 120.0050.038



Finish	
	Chrome 120.0050.038 €1077
	SilkSteel 120.0050.039 €1175

Tap base diameter 53mm  
Tap cut-out 35mm  
Spray base diameter 50mm  
Spray cut-out 30mm  
Max depth worktop 57mm

3 WEEK DELIVERY

### Franke Trispray Doric

(1) Pictured Tap 120.0050.030



Finish	
	Chrome 120.0050.030 €999
	SilkSteel 120.0050.031 €1165

Tap base diameter 60mm  
Tap cut-out 35mm  
Spray base diameter 50mm  
Spray cut-out 30mm  
Max depth worktop 57mm

### Franke Trispray Tradition

(1) Pictured Tap 120.0050.019



	Chrome 120.0050.019 €979
--	-----------------------------

3 WEEK DELIVERY

Tap base diameter 60mm  
Tap cut-out 35mm  
Spray base diameter 50mm  
Spray cut-out 30mm  
Max depth worktop 57mm

Recommended minimum hot pressure for Franke Trisprays is 1 bar.

(1) Ceramic disc tap – may require a 4 metre head of water in a conventional plumbing system.  
In some instances, pull-out nozzle and spray taps may require additional pumping or local authority approval prior to installation.  
Franke strongly recommends that you consult your supplier/installer prior to purchase.

The figure in the symbol is designed to indicate the relative flow rate performance for each tap. The rate is graded 1-8 where 1 is poor and 8 is excellent. Relative flow rates are only likely to be relevant in installations with a low head of water (below 4 metres) or low cold supply pressure. In either case you would be well advised to consult your supplier or installer.

Franke\* Triflow\*\* are registered trademarks of \*Franke and \*\*Triflow Concepts Ltd respectively.  
All prices inclusive of V.A.T @ 21%

## Franke Little Butler

Forget waiting for the kettle to boil. With the Franke Little Butler hot water tap, near-boiling water for tea, coffee, soups and cooking is at your fingertips whenever you need it.

Convenient, simple and easy to operate, the Franke Little Butler is the perfect sink-side addition for a busy kitchen. The Franke Little Butler 2000 offers all the features of the Franke Little Butler 1000 but with two levers and has the added advantage of dispensing perfectly filtered drinking water on tap.

Enjoy freshly filtered water free of contaminants, impurities and bad odours. Compact and unobtrusive, the easily replaceable cartridge's unique properties remove bacteria, contaminants, cysts, chemicals and odours. You can have both steaming hot and filtered water – right at your fingertips.



## Soap Dispenser



Available in Chrome or SilkSteel, the Franke Soap Dispenser provides a fast and easy to operate neat hand pump for all liquid soaps. It fits neatly and unobtrusively alongside sinks in the worktop, its design carefully chosen to complement the qualities of the Specialist tap range.

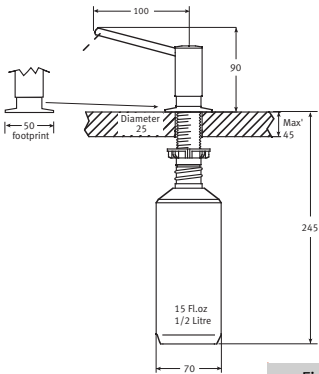

Finish	
Chrome	€87
119.0049.852	
SilkSteel	€98
119.0049.853	

## Waste Bin



The Franke Waste Bin is an inset stainless steel system with a standard 12 litre polyethylene container. This clever feature fits flush with the worktop, allowing you to scoop in waste with ease. Replace the cover and the unit is concealed with odours safely sealed inside. The container simply lifts out when it needs emptying.

3 WEEK DELIVERY

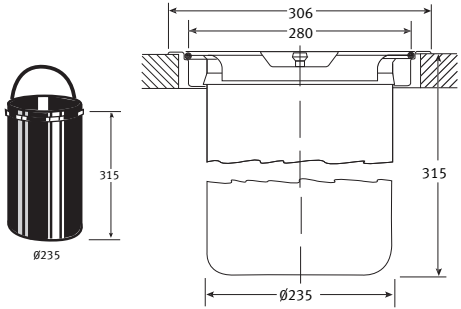

With Synthetic Bin 12 Litre	€257
134.0035.042	





# Waste Disposal Units

A choice of four units designed to free the kitchen of unsightly and unhygienic organic household waste. Each unit is the essential add-on for ensuring that all Franke appliances and work surfaces remain looking immaculate.

Thanks to a unique permanent magnet motor, Franke Turbo Waste Disposal Units reach high speed in a split second, producing more torque per kilo than any other of its type. Whilst running water through the unit, food waste is instantly liquefied into fine particles that are easily flushed through the pipework system.

4 WEEK DELIVERY

## Franke Turbo WD-500

134.0049.848



### Type

Continuous Feed\* €298

Motor horsepower: 1/2 HP

Motor speed RPM: 2600

Motor type: High Torque dual magnetic motor

\*Air switch: Integral

Mounting system: Professional 3-bolt

Warranty: 8 years

### Type

Continuous Feed\* €466

## Franke Turbo WD-751

134.0049.849



Motor horsepower: 3/4 HP

Motor speed RPM: 2700

Motor type: High Torque dual magnetic motor

\*Air switch: Integral

Mounting system: Professional 3-bolt

Warranty: 10 years

4 WEEK DELIVERY

## Franke Turbo WD-1001

134.0049.850



### Type

Continuous Feed\* €609

Motor horsepower: 1 HP

Motor speed RPM: 2800

Motor type: High Torque dual magnetic motor

\*Air switch: Integral

Mounting system: Professional 3-bolt

Warranty: Lifetime

### Type

Batch Feed\*\* €511

4 WEEK DELIVERY

## Franke Turbo WD-1001B

134.0049.851



Motor horsepower: 1 HP

Motor speed RPM: 2800

Motor type: High Torque dual magnetic motor

Air switch: Not applicable

Mounting system: Professional 3-bolt

Warranty: 10 years

\*Continuous Feed models are operated by an Air Switch (or alternative) and waste food is fed through the open neck of the unit.

\*\*Batch Feed model is activated by loading the chamber and rotating the WDU plug.

In both cases, a continuous supply of water is necessary whilst the WDU is in use. Member of REPIC for WEEE Regulations. EEE Producer Registration Number - WEE/DG0059TT.

NB. Ensure WDU dimensions can be accommodated within the specified cabinet width — see page 58.

All prices inclusive of V.A.T @ 21%

# Franke Waste Sorters

Our aim to bring Franke excellence to every aspect of the kitchen continues with the introduction of more options to aid with the environmentally friendly sorting and disposal of household waste.



## Soft-close drawer systems

The Franke 350 series waste sorters have been designed to be installed into modern soft-close drawer systems including Blum (Tandembox), Hettich (Quadro V6) and Grass (Nova pro)\*. The Sorter Solo 50 and Solo 60 are mounted on a standard cabinet side wall to offer a convenient waste solution.

3 WEEK DELIVERY

### Sorter 350-50

- Includes system lid with integrated charcoal filter.
- Received in cabinet floor.



Cabinet width  
500mm

Sorter 350-50  
€190  
121.0033.259

3 WEEK DELIVERY

### Sorter 350-60

- Includes system lid with integrated charcoal filter.
- Received in cabinet floor.



Cabinet width  
600mm

Sorter 350-60  
€238  
121.0033.227

### Collect Bag



Collect Bag  
€24  
133.0038.258



3 WEEK DELIVERY

### Sorter Solo 50 & Solo 60

- 40 litre waste bin, take 35 litre bag or 2 x 17 litre bags
- Includes system lid with integrated charcoal filter
- Mounted on standard cabinet side wall



Cabinet width  
Solo 50 fits 500mm cabinets  
Solo 60 fits 600mm cabinets

Solo 50 €127  
121.0030.542  
Solo 60 €143  
121.0033.246

As separating household waste into recyclable groups becomes more of a green lifestyle necessity, Franke Sorter systems are a useful addition to any kitchen, fitting neatly into most 500mm and 600mm cabinets. Franke waste systems feature separate plastic containers to sort domestic waste into different categories such as food, cans, plastic and paper, which can then be systematically disposed of or recycled. A lid closes over the bins to contain any odours. Franke Sorters are the natural alternative to the conventional waste bin.



NB. When fitting under the sink (particularly undermounts) ensure that the dimensions can be accommodated.

## Standard door systems

The Franke 700 series sorter systems are a useful addition to any kitchen with standard doors, fitting neatly into 500mm and 600mm kitchen base units. With both pedal-operated and hand-operated versions available, Franke Sorters are the natural alternative to the conventional waste bin. The 700 series is available as either a foot-activated 'Kickmatic' model or the easy-to-use hand-operated 'Motion' soft-close mechanism. Each bin has a handle that can also be used to secure waste bags. The roll-out carrier is fully waterproof, simple to dismantle and easy to clean.

3 WEEK DELIVERY

Sorter 700 M 45

Sorter 700 K 45



Sorter 700 M  
(Motion) 45 €288  
121.0007.502

Sorter 700 K  
(KickMatic) 45 €307  
121.0007.499

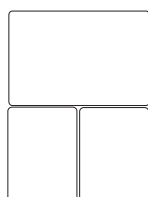

Cabinet size: 500mm

Sorter 700 M 60

Sorter 700 K 60



Sorter 700 M  
(Motion) 60 €288  
121.0007.504

Sorter 700 K  
(KickMatic) 60 €307  
121.0007.501



Cabinet size: 600mm

## Stainless Steel Sinks

### Ariane

ARX 654



**Overall size:** 1000 x 510  
**Bowl sizes:** 350 x 435 x 180  
 170 x 320 x 135  
**Cut-out size:** 984 x 494 cr=20  
**Cabinet size:** 600  
**Finish:** Silk  
  
 LHD 101.0018.651  
 RHD 101.0018.652

### Beach

BBX 651



**Overall size:** 1000 x 510  
**Bowl size:** 560 x 425 x 175  
**Cut-out size:** 984 x 494 cr=20  
**Cabinet size:** 600  
**Finish:** Silk  
  
 101.0039.639

### Compact

CPX 610



**Overall size:** 400 x 480  
**Bowl size:** 340 x 420 x 175  
**Cut-out size:** 384 x 464 cr=20  
**Cabinet size:** 450  
**Finish:** Silk  
  
 101.0018.203

3 WEEK DELIVERY

CPX 611 780



**Overall size:** 780 x 500  
**Bowl size:** 340 x 420 x 175  
**Cut-out size:** 764 x 484 cr=20  
**Cabinet size:** 450  
**Finish:** Silk  
  
 LHD 101.0066.066  
 RHD 101.0066.080

CRX 651



**Overall size:** 965 x 500  
**Bowl sizes:** 340 x 420 x 175  
 165 x 300 x 130  
**Cut-out size:** 949 x 484 cr=20  
**Cabinet size:** 600  
**Finish:** Silk  
  
 101.0018.860

CPX 651



**Overall size:** 965 x 500  
**Bowl sizes:** 340 x 420 x 175  
 165 x 300 x 130  
**Cut-out size:** 949 x 484 cr=20  
**Cabinet size:** 600  
**Finish:** Silk  
  
 LHD 101.0066.084  
 RHD 101.0066.129

CPX 652-E



**Overall size:** 1050 x 500  
**Bowl sizes:** 340 x 420 x 175  
 165 x 300 x 130  
**Cut-out size:** 1034/584 x 484  
**Cabinet size:** 600  
**Finish:** Silk  
  
 101.0066.154

3 WEEK DELIVERY

CNX 660



**Overall size:** 615 x 500  
**Bowl sizes:** 340 x 420 x 175  
 175 x 330 x 130  
**Cut-out size:** 599 x 484 cr=20  
**Cabinet size:** 600  
**Finish:** Silk  
  
 101.0066.051

### Infinito

INX 611



**Overall size:** 1000 x 500  
**Bowl size:** 450 x 400 x 190  
**Cut-out size:** 980 x 480 cr=20  
**Cabinet size:** 600  
**Finish:** Silk  
  
 LHD 101.0022.105  
 RHD 101.0022.104

STX 621-E



**Overall size:** 830 x 830  
**Bowl sizes:** 400 x 340 x 190  
 300 x 340 x 170  
**Cut-out size:** Utilise template  
**Cabinet size:** 900 x 900 corner unit  
**Finish:** Silk  
  
 LHD 101.0022.125  
 RHD 101.0022.124

3 WEEK DELIVERY

### Laser

LSX 611



**Overall size:** 895 x 510  
**Bowl size:** 390 x 445 x 175  
**Cut-out size:** 882 x 497 cr=10  
 Utilise template  
**Cabinet size:** 500  
**Finish:** Silk  
  
 LHD 101.0066.683  
 RHD 101.0066.686

LSX 651



**Overall size:** 990 x 500  
**Bowl sizes:** 350 x 435 x 180  
 165 x 300 x 130  
**Cut-out size:** 977 x 487 cr=10  
 Utilise template  
**Cabinet size:** 600  
**Finish:** Silk  
  
 LHD 101.0046.522  
 RHD 101.0046.523

### Mythos

MMX 611



**Overall size:** 1000 x 520  
**Bowl size:** 450 x 400 x 197  
**Cut-out size:** 984 x 509 cr=20  
**Cabinet size:** 500  
**Finish:** Silk  
  
 LHD 101.0051.470  
 RHD 101.0051.471

MMX 651



**Overall size:** 1000 x 520  
**Bowl sizes:** 340 x 400 x 192  
 160 x 400 x 135  
**Cut-out size:** 989 x 509 cr=20  
**Cabinet size:** 600  
**Finish:** Silk  
  
 LHD 101.0051.473  
 RHD 101.0051.475

## Nobel

NOX 614



**Overall size:** 965 x 500  
**Bowl size:** 420 x 420 x 180  
**Cut-out size:** 949 x 484 cr=20  
**Cabinet size:** 500†  
**Finish:** Silk

LHD 101.0019.460  
 RHD 101.0019.467

†Cabinet width may require modification to accommodate overflow.

## Planar

PPX 611



**Overall size:** 1000 x 510  
**Bowl size:** 470 x 410 x 195  
**Cut-out size:** 984 x 494 cr=20  
 Utilise template  
**Cabinet size:** 600  
**Finish:** Silk

LHD 101.0045.976  
 RHD 101.0050.482

PPX 651



**Overall size:** 1000 x 510  
**Bowl sizes:** 340 x 410 x 195  
 160 x 410 x 130  
**Cut-out size:** 984 x 494 cr=20  
 Utilise template  
**Cabinet size:** 600  
**Finish:** Silk

LHD 101.0027.766  
 RHD 101.0025.289

## Rotondo

RBX 610



**Overall size:** ø440  
**Bowl size:** ø395 Diameter  
 x 170 Depth  
**Cut-out size:** ø425  
**Cabinet size:** 500  
**Finish:** Brushed

LHD 101.0033.751

RBX 604



**Overall size:** ø440  
**Bowl size:** ø395 Diameter  
 x 35 Depth  
**Cut-out size:** ø425  
**Cabinet size:** 500  
**Finish:** Polished

LHD 101.0050.182

## UK

UKX 612



**Overall size:** 1500 x 500  
**Bowl size:** 450 x 360 x 180  
**Cut-out size:** 1484 x 484 cr=20  
**Cabinet size:** 500  
**Finish:** Silk

LHD 101.0018.930

## Fragranite

## Mythos

MTG 611



**Overall size:** 1000 x 515  
**Bowl size:** 500 x 390 x 200  
**Cut-out size:** 984 x 494 cr=10  
 Utilise template  
**Cabinet size:** 600

**Finish:** SilkSheen

Polar White Graphite

LHD 114.0045.906 LHD 114.0046.308  
 RHD 114.0045.305 RHD 114.0046.309

MTG 651-100



**Overall size:** 1000 x 515  
**Bowl sizes:** 360 x 390 x 200  
 160 x 390 x 140  
**Cut-out size:** 984 x 494 cr=10  
 Utilise template  
**Cabinet size:** 600

**Finish:** SilkSheen

Polar White Graphite

LHD 114.0046.313 LHD 114.0046.310  
 RHD 114.0046.314 RHD 114.0046.311

## Glass

## Kubus

KBV 611



**Overall size:** 1000 x 530  
**Bowl size:** 450 x 400 x 180  
**Cut-out size:** 980 x 510  
**Cabinet size:** 500

**Finish:** Glass

Aqua Black

LHD 101.0052.361 LHD 101.0052.390  
 RHD 101.0052.367 RHD 101.0052.393

KBV 651



**Overall size:** 1000 x 530  
**Bowl sizes:** 340 x 400 x 175  
 160 x 400 x 130  
**Cut-out size:** 980 x 510  
**Cabinet size:** 600

**Finish:** Glass

Aqua Black

LHD 101.0052.370 LHD 101.0052.397  
 RHD 101.0052.388 RHD 101.0052.398

## Belfast/Ceramic Inset

### Belfast

VBK 710



**Overall size:** 600 x 500  
**Bowl size:** 565 x 430 x 180  
 Ext. bowl depth: 200  
**Cut-out size:** N/A  
**Cabinet size:** 600  
**Finish:** Ceramic White  
 130.0049.875

VBK 710-60



**Overall size:** 595 x 630  
**Bowl size:** 535 x 440 x 185  
 Ext. bowl depth: 220  
**Cut-out size:** N/A  
**Cabinet size:** 600  
**Finish:** Ceramic White  
 130.0049.877

VBK 720



**Overall size:** 800 x 500  
**Bowl sizes:** 370 x 465 x 200(x2)  
 Ext. bowl depth: 220  
**Cut-out size:** N/A  
**Cabinet size:** 800  
**Finish:** Ceramic White  
 130.0049.876

NB: Tap Centres 190mm

### Mythos

MTK 611



**Overall size:** 1000 x 510  
**Bowl size:** 505 x 350 x 200  
**Cut-out size:** 970 x 480 cr=20  
**Cabinet size:** 600

**Finish:** Ceramic

White

Black

LHD 124.0050.117

LHD 124.0050.119

RHD 124.0050.118

RHD 124.0050.120

MTK 651



**Overall size:** 1000 x 510  
**Bowl sizes:** 300 x 350 x 200  
 175 x 350 x 155  
**Cut-out size:** 970 x 480 cr=20  
**Cabinet size:** 600

**Finish:** Ceramic

White

Black

LHD 124.0050.121

LHD 124.0050.123

RHD 124.0050.122

RHD 124.0050.124

### VBK

VBK 651



**Overall size:** 1000 x 510  
**Bowl sizes:** 345 x 400 x 170  
 140 x 250 x 110  
**Cut-out size:** 970 x 470 cr=20  
**Cabinet size:** 600  
**Finish:** Ceramic White  
  
 LHD 124.0049.872  
 RHD 124.0049.873

### Belfast

BFX 710













**Overall size:** 600 x 500  
**Bowl size:** 500 x 400 x 200  
 Ext. bowl depth: 200  
**Cut-out size:** N/A  
**Cabinet size:** 600  
**Finish:** Silk  
 123.0050.185

## Single Bowl Undermount Sinks

Ariane			Compact			Largo			Oceana			Rotondo			UK		
ARX 110 17		<b>Bowl size:</b> 170 x 320 x 130 <b>Cut-out size:</b> Utilise template <b>Cabinet size:</b> 300 <b>Finish:</b> Silk  112.0046.532	ARX 110 17D		<b>Bowl size:</b> 170 x 435 x 130 <b>Cut-out size:</b> Utilise template <b>Cabinet size:</b> 300 <b>Finish:</b> Silk  112.0046.414	ARX 110 33		<b>Bowl size:</b> 330 x 350 x 160 <b>Cut-out size:</b> Utilise template <b>Cabinet size:</b> 500 <b>Finish:</b> Silk  122.0036.285	<b>3 WEEK DELIVERY</b>								
ARX 110 35		<b>Bowl size:</b> 350 x 435 x 180 <b>Cut-out size:</b> Utilise template <b>Cabinet size:</b> 500 <b>Finish:</b> Silk  122.0036.336	CPX 110 16		<b>Bowl size:</b> 165 x 300 x 130 <b>Cut-out size:</b> Utilise template <b>Cabinet size:</b> 300 <b>Finish:</b> Silk  112.0046.088	CPX 110 34		<b>Bowl size:</b> 340 x 420 x 175 <b>Cut-out size:</b> Utilise template <b>Cabinet size:</b> 500 <b>Finish:</b> Silk  122.0035.386									
LAX 110 45		<b>Bowl size:</b> 445 x 390 x 175 <b>Cut-out size:</b> Utilise template <b>Cabinet size:</b> 500 <b>Finish:</b> Silk  122.0066.736	LAX 110 50		<b>Bowl size:</b> 500 x 350 x 180 <b>Cut-out size:</b> Utilise template <b>Cabinet size:</b> 600 <b>Finish:</b> Silk  122.0035.334	OAX 110 <sup>†</sup>		<b>Bowl size:</b> 710 x 430 x 226 <b>Cut-out size:</b> Utilise template <b>Cabinet size:</b> 800 <b>Finish:</b> Silk  122.0052.085									
RUX 110		<b>Bowl size:</b> ø395 x 170 <b>Cut-out size:</b> Utilise template <b>Cabinet size:</b> 500 <b>Finish:</b> Silk  127.0050.183	UKX 110 45		<b>Bowl size:</b> 450 x 360 x 180 <b>Cut-out size:</b> Utilise template <b>Cabinet size:</b> 500 <b>Finish:</b> Silk  122.0036.577												

## Multi-Bowl Undermount Sinks

Ariane			Compact					
ARX 160		<b>Bowl sizes:</b> 350 x 435 x 180 170 X 320 X 130 <b>Cut-out size:</b> Utilise template <b>Cabinet size:</b> 600 <b>Finish:</b> Silk  LHSB 122.0040.304 RHSB 122.0040.305	ARX 160D		<b>Bowl sizes:</b> 350 x 435 x 180 170 x 435 x 130 <b>Cut-out size:</b> Utilise template <b>Cabinet size:</b> 600 <b>Finish:</b> Silk  LHSB 122.0040.388 RHSB 122.0040.389	CPX 160		<b>Bowl sizes:</b> 340 x 420 x 175 165 X 300 X 130 <b>Cut-out size:</b> Utilise template <b>Cabinet size:</b> 600 <b>Finish:</b> Silk  LHSB 122.0040.278 RHSB 122.0040.279
GAX 120		<b>Bowl sizes:</b> 450 x 400 x 190 300 X 340 X 170 <b>Cut-out size:</b> Utilise template <b>Cabinet size:</b> 900 <b>Finish:</b> Silk  122.0021.417						
Right hand small bowl only.								
RGX 120 <sup>†</sup>		<b>Bowl sizes:</b> 395 x 480 x 230(x2) <b>Cut-out size:</b> Utilise template <b>Cabinet size:</b> 1000 <b>Finish:</b> Silk  122.0032.918						

## Beach Undermount Sink

### Beach

BBX 160†



**Bowl size:** 560 x 425 x 175  
**Cut-out size:** Utilise template  
**Cabinet size:** 600  
**Finish:** Silk  
  
 122.0039.772

## Bolero Undermount Sinks

### Bolero

**Bowl size:** 500 x 435 x 185

BOX 110 17



**Bowl size:** 170 x 320 x 130  
**Cut-out size:** Utilise template  
**Cabinet size:** 300  
**Finish:** Silk  
  
 122.0049.817

BOX 110 35



**Bowl size:** 350 x 435 x 185  
**Cut-out size:** Utilise template  
**Cabinet size:** 500  
**Finish:** Silk  
  
 122.0049.815

BOX 110 50



**Cut-out size:** Utilise template  
**Cabinet size:** 600  
**Finish:**   
 122.0049.816

BOX 160D



**Bowl sizes:** 340 x 400 x 185  
 150 x 400 x 150  
**Cut-out size:** Utilise template  
**Cabinet size:** 600  
**Finish:** Silk  
  
 LHSB 122.0049.818  
 RHSB 122.0049.819

## Kubus Stainless Steel Undermount Sinks

### Kubus

KBX 104 45<sup>‡</sup>



**Bowl size:** 450 x 400 x 25  
**Cut-out size:** Utilise template  
**Cabinet size:** 500  
**Finish:** Silk  
  
 112.0043.894

KBX 110 16



**Bowl size:** 160 x 340 x 130  
**Cut-out size:** Utilise template  
**Cabinet size:** 300  
**Finish:** Silk  
  
 112.0043.864

KBX 110 20



**Bowl size:** 200 x 400 x 150  
**Cut-out size:** Utilise template  
**Cabinet size:** 300  
**Finish:** Silk  
  
 112.0043.874

KBX 110 34



**Bowl size:** 340 x 400 x 175  
**Cut-out size:** Utilise template  
**Cabinet size:** 500  
**Finish:** Silk  
  
 122.0036.607

KBX 110 45



**Bowl size:** 450 x 400 x 180  
**Cut-out size:** Utilise template  
**Cabinet size:** 600  
**Finish:** Silk  
  
 122.0036.608

KBX 110 55



**Bowl size:** 550 x 400 x 190  
**Cut-out size:** Utilise template  
**Cabinet size:** 600  
**Finish:** Silk  
  
 122.0036.609

KBX 160 34-16



**Bowl sizes:** 340 x 400 x 175  
 160 x 340 x 130  
**Cut-out size:** Utilise template  
**Cabinet size:** 600  
**Finish:** Silk  
  
 LHSB 122.0033.122  
 RHSB 122.0033.137

KBX 160 45-20



**Bowl sizes:** 450 x 400 x 180  
 200 x 400 x 150  
**Cut-out size:** Utilise template  
**Cabinet size:** 800  
**Finish:** Silk  
  
 LHSB 122.0033.140  
 RHSB 122.0033.141





KBX 120 34-34







**Bowl sizes:** 340 x 400 x 175  
 340 x 400 x 175  
**Cut-out size:** Utilise template  
**Cabinet size:** 900  
**Finish:** Silk  
  
 122.0061.524



## Kubus Fraganite Undermount Sinks

Kubus					
<b>KBG 110 16</b> 	<b>Bowl size:</b> 160 x 400 x 130 <b>Cut-out size:</b> Utilise template <b>Cabinet size:</b> 300 <b>Finish:</b> SilkSheen Polar White <input type="text"/> 125.0046.869 Graphite <input type="text"/> 125.0046.870	<b>KBG 110 34</b> 	<b>Bowl size:</b> 340 x 400 x 210 <b>Cut-out size:</b> Utilise template <b>Cabinet size:</b> 400 <b>Finish:</b> SilkSheen Polar White <input type="text"/> 125.0046.871 Graphite <input type="text"/> 125.0046.872	<b>KBG 110 50</b> 	<b>Bowl size:</b> 500 x 400 x 210 <b>Cut-out size:</b> Utilise template <b>Cabinet size:</b> 600 <b>Finish:</b> SilkSheen Polar White <input type="text"/> 125.0046.874 Graphite <input type="text"/> 125.0046.875
<b>KBG 160</b>  Right hand small bowl only.	<b>Bowl sizes:</b> 340 x 400 x 210 160 x 400 x 130 <b>Cut-out size:</b> Utilise template <b>Cabinet size:</b> 600 <b>Finish:</b> SilkSheen Polar White <input type="text"/> 125.0046.877 Graphite <input type="text"/> 125.0046.878				

## Ceramic Undermount Sinks

Rotondo					
<b>RUK 110</b> 	<b>Bowl size:</b> ø390 x 180 <b>Cut-out size:</b> Utilise template <b>Cabinet size:</b> 500 <b>Finish/Price:</b> Ceramic White <input type="text"/> 126.0050.125 Black <input type="text"/> NEW 126.0066.527				
<b>VBK</b>					
<b>VBK 160*</b>  Left hand small bowl only.	<b>Bowl sizes:</b> 343 x 390 x 173 136 x 272 x 103 <b>Cut-out size:</b> Utilise template <b>Cabinet size:</b> 600 <b>Finish/Price:</b> Ceramic White <input type="text"/> 126.0050.115 Black <input type="text"/> NEW 126.0066.532	<b>VBK 110 21</b> 	<b>Bowl size:</b> 210 x 390 x 180 <b>Cut-out size:</b> Utilise template <b>Cabinet size:</b> 500 <b>Finish:</b> Ceramic White <input type="text"/> 126.0066.541 Black <input type="text"/> NEW 126.0066.542	<b>VBK 110 33</b> 	<b>Bowl size:</b> 325 x 390 x 175 <b>Cut-out size:</b> Utilise template <b>Cabinet size:</b> 500 <b>Finish:</b> Ceramic White <input type="text"/> 126.0066.547 Black <input type="text"/> NEW 126.0066.550

## Specialist Taps

### Rolux

NEW (1) 4 P



**Tap Height:** 404  
**Spout Reach:** 225  
**Base Diameter:** 52  
**Tap cut-out:** 35  
**Finish:**  
 Chrome  
 115.0068.025

### Panto

NEW (1) 6 P



**Tap Height:** 401  
**Spout Reach:** 183  
**Base Diameter:** 54  
**Tap cut-out:** 35  
**Finishes:**  
 Stainless Steel  
 115.0063.559

### Eos

NEW (1) 5 P



**Tap Height:** 418  
**Spout Reach:** 183  
**Base Diameter:** 54  
**Tap cut-out:** 35  
**Finishes:**  
 Stainless Steel  
 115.0063.568

### Ticino

NEW (1) 5 P



**Tap Height:** 245  
**Spout Reach:** 203  
**Base Diameter:** 58 x 48  
**Tap cut-out:** 35  
**Finishes:**  
 Chrome  
 115.0068.026  
 SilkSteel  
 115.0068.027

### Basel

NEW (1) 6 P



**Tap Height:** 388  
**Spout Reach:** 225  
**Base Diameter:** 52  
**Tap cut-out:** 35  
**Finishes:**  
 Chrome  
 115.0068.028  
 SilkSteel  
 115.0068.029

### Mythos MTX

(1) 6



**Tap Height:** 365  
**Spout Reach:** 210  
**Base Diameter:** 46  
**Tap cut-out:** 35  
**Finish:**  
 Chrome  
 115.0049.965  
 SilkSteel  
 115.0049.966

### Mythos MTG

(1) 6



Graphite or White shoulders

**Tap Height:** 365  
**Spout Reach:** 210  
**Base Diameter:** 46  
**Tap cut-out:** 35  
**Finish:**  
 Chrome  
 115.0049.967 – Graphite Shoulders  
 115.0049.969 – White Shoulders  
 SilkSteel  
 115.0049.968 – Graphite Shoulders  
 115.0049.970 – White Shoulders

### Mythos MTV

(2) 6



Available with Black shoulders only

**Tap Height:** 365  
**Spout Reach:** 210  
**Base Diameter:** 46  
**Tap cut-out:** 35  
**Finish:**  
 Chrome  
 115.0051.536  
 SilkSteel  
 115.0051.539

### Mythos Pull-out Nozzle

(1) 5



**Tap Height:** 390  
**Spout Reach:** 210  
**Base Diameter:** 57  
**Tap cut-out:** 35  
**Finish:**  
 SilkSteel  
 115.0049.964

### Davos 'J'

(1) 7



**Tap Height:** 400  
**Spout Reach:** 221  
**Base Diameter:** 55  
**Tap cut-out:** 35  
**Finish:**  
 Chrome  
 115.0050.044  
 SilkSteel  
 115.0049.940

### Davos

(1) 8



**Tap Height:** 245  
**Spout Reach:** 230  
**Base Diameter:** 55  
**Tap cut-out:** 35  
**Finish:**  
 Chrome  
 115.0046.694  
 SilkSteel  
 115.0046.695

### Olympus

(1) 6 P



**Tap Height:** 390  
**Spout Reach:** 220  
**Base Diameter:** 60  
**Tap cut-out:** 35  
**Finish:**  
 Chrome  
 115.0049.980  
 SilkSteel  
 115.0049.979

### Olympus U-Spout

(1) 6 P



**Tap Height:** 370  
**Spout Reach:** 240  
**Base Diameter:** 60  
**Tap cut-out:** 35  
**Finish:**  
 Chrome  
 115.0051.544  
 SilkSteel  
 115.0051.545

### Olympus Side Spray

(1) 6 P



**Tap Height:** 390  
**Spout Reach:** 220  
**Base Diameter:** 60  
**Tap cut-out:** 35  
**Finish:**  
 Chrome  
 115.0051.538  
 NB. Cold spray only.

### Rotaflow

(2) 7 P



**Tap Height:** 320  
**Spout Reach:** 190  
**Base Diameter:** 45  
**Tap cut-out:** 35  
**Finish:**  
 Chrome  
 115.0049.950  
 SilkSteel  
 115.0049.949

### Orca

(1) 6



**Tap Height:** 194  
**Spout Reach:** 225  
**Base Diameter:** 52  
**Tap cut-out:** 35  
**Finish:**  
 Chrome  
 115.0050.002  
 SilkSteel  
 115.0050.003

### Orca Spray Pull-out Spray

(1) 5



**Tap Height:** 184  
**Spout Reach:** 225  
**Base Diameter:** 52  
**Tap cut-out:** 35  
**Finish:**  
 Chrome  
 115.0050.004  
 SilkSteel  
 115.0050.005

(1) Ceramic disc tap – may require a 4 metre head of water in a conventional plumbing system. (2) Compression valve tap – usually suitable for any plumbing system. In some instances, pull-out nozzle and spray taps may require additional pumping or local authority approval prior to installation.

Frankle strongly recommends that you consult your supplier/installer prior to purchase.

1 The figure in the symbol is designed to indicate the relative flow rate performance for each tap. The rate is graded 1-8 where 1 is poor and 8 is excellent. Relative flow rates are only likely to be relevant in installations with a low head of water (below 4 metres) or low cold supply pressure. In either case you would be well advised to consult your supplier or installer.

All Franke taps are designed to conform to Water Research Council requirements and are backed by nationwide servicing and guarantees.

P Indicates tap is fitted with a Perlator® providing a champagne-like flow.

<p><b>Eiger</b></p> <p>(1)   </p>  <p><b>Tap Height:</b> 380 <b>Spout Reach:</b> 230 <b>Base Diameter:</b> 55 <b>Tap cut-out:</b> 35 <b>Finish:</b>   Chrome 115.0049.989   SilkSteel 115.0049.990</p>	<p><b>Eiger U-Spout</b></p> <p>(1)   </p>  <p><b>Tap Height:</b> 365 <b>Spout Reach:</b> 240 <b>Base Diameter:</b> 55 <b>Tap cut-out:</b> 35 <b>Finish:</b>   Chrome 115.0051.540   SilkSteel 115.0051.541</p>	<p><b>Eiger (White Levers)</b></p> <p>(1)   </p>  <p><b>Tap Height:</b> 380 <b>Spout Reach:</b> 230 <b>Base Diameter:</b> 55 <b>Tap cut-out:</b> 35 <b>Finish:</b>   Chrome 115.0049.991   SilkSteel 115.0049.992</p>
<p><b>Gotthard</b></p> <p>(1)   </p>  <p><b>Tap Height:</b> 380 <b>Spout Reach:</b> 230 <b>Base Diameter:</b> 55 <b>Tap cut-out:</b> 35 <b>Finish:</b>   Chrome 115.0049.993   SilkSteel 115.0049.994</p>	<p><b>Gotthard (White Levers)</b></p> <p>(1)   </p>  <p><b>Tap Height:</b> 380 <b>Spout Reach:</b> 230 <b>Base Diameter:</b> 55 <b>Tap cut-out:</b> 35 <b>Finish:</b>   Chrome 115.0049.995   SilkSteel 115.0049.996</p>	<p><b>Fuji</b></p> <p>(1)   </p>  <p><b>Tap Height:</b> 390 <b>Spout Reach:</b> 220 <b>Base Diameter:</b> 60 <b>Tap cut-out:</b> 35 <b>Finish:</b>   Chrome 115.0049.985   SilkSteel 115.0049.986</p>
<p><b>Fuji Pull-out Nozzle</b></p> <p>(1)   </p>  <p><b>Tap Height:</b> 390 <b>Spout Reach:</b> 230 <b>Base Diameter:</b> 60 <b>Tap cut-out:</b> 35 <b>Finish:</b>   Chrome 115.0049.987   SilkSteel 115.0049.988</p>	<p><b>Belfast Pull-out Nozzle</b></p> <p>(1)  </p>  <p><b>Tap Height:</b> 440 <b>Spout Reach:</b> 250 <b>Base Diameter:</b> 50 <b>Tap cut-out:</b> 35 <b>Finish:</b>   Chrome 115.0049.997   SilkSteel 115.0049.998</p>	<p><b>Pilatus</b></p> <p>(1) </p>  <p><b>Tap Height:</b> 303 <b>Spout Reach:</b> 192 <b>Base Diameter:</b> 50 <b>Tap cut-out:</b> 35 <b>Finish:</b>   Chrome 115.0049.971   SilkSteel 115.0049.972</p>
<p><b>Pilatus PowerStream</b></p> <p>(1) </p>  <p><b>Tap Height:</b> 262 <b>Spout Reach:</b> 215 <b>Base Diameter:</b> 50 <b>Tap cut-out:</b> 35 <b>Finish:</b>   Chrome 115.0049.973   SilkSteel 115.0049.974</p>	<p><b>Bridge</b></p> <p>(2)  </p>  <p><b>Tap Height:</b> 365 <b>Spout Reach:</b> 180 <b>Requires tap holes:</b> 25 centres min 125 max 235 <b>Finish:</b>   Chrome 115.0049.960   Gold 115.0049.961</p>	<p><b>Bridge Lever</b></p> <p>(2)  </p>  <p><b>Tap Height:</b> 365 <b>Spout Reach:</b> 180 <b>Requires tap holes:</b> 25 centres min 125 max 235 <b>Finish:</b>   Chrome 115.0049.962   SilkSteel 115.0049.963</p>
<p><b>Planar</b></p> <p>(1)   </p>  <p><b>Tap Height:</b> 360 <b>Spout Reach:</b> 190 <b>Base Diameter:</b> 44 <b>Tap cut-out:</b> 35 <b>Finish:</b>   Chrome 115.0049.999   SilkSteel 115.0050.000</p>	<p><b>Kubus</b></p> <p>(1)  </p>  <p><b>Tap Height:</b> 324 <b>Spout Reach:</b> 210 <b>Effective Spout Reach:</b> 185 <b>Base:</b> 50 x 60 <b>Tap cut-out:</b> 35 <b>Finish:</b>   Chrome 115.0050.008   SilkSteel 115.0050.009</p>	

(1) Ceramic disc tap – may require a 4 metre head of water in a conventional plumbing system. (2) Compression valve tap – usually suitable for any plumbing system. In some instances, pull-out nozzle and spray taps may require additional pumping or local authority approval prior to installation.

Franke strongly recommends that you consult your supplier/installer prior to purchase.

The figure in the symbol is designed to indicate the relative flow rate performance for each tap. The rate is graded 1-8 where 1 is poor and 8 is excellent. Relative flow rates are only likely to be relevant in installations with a low head of water (below 4 metres) or low cold supply pressure. In either case you would be well advised to consult your supplier or installer.

All Franke taps are designed to conform to Water Research Council requirements and are backed by nationwide servicing and guarantees.

Indicates tap is fitted with a Perlator® providing a champagne-like flow.

NB. No reliance should be placed on dimensions given, which are for guidance only. For full specifications on all Franke products visit [www.franke.co.uk](http://www.franke.co.uk)

## Swiss Pro

(1) 4 P



**Tap Height:** 705  
**Spout Reach:** 250  
**Base Diameter:** 50  
**Tap cut-out:** 35  
**Finish:**  
Chrome  
115.0050.001

(1) Ceramic disc tap – may require a 4 metre head of water in a conventional plumbing system. (2) Compression valve tap – usually suitable for any plumbing system. In some instances, pull-out nozzle and spray taps may require additional pumping or local authority approval prior to installation.

Franke strongly recommends that you consult your supplier/installer prior to purchase.

1 The figure in the symbol is designed to indicate the relative flow rate performance for each tap. The rate is graded 1-8 where 1 is poor and 8 is excellent. Relative flow rates are only likely to be relevant in installations with a low head of water (below 4 metres) or low cold supply pressure. In either case you would be well advised to consult your supplier or installer.

All Franke taps are designed to conform to Water Research Council requirements and are backed by nationwide servicing and guarantees.











P Indicates tap is fitted with a Perlator® providing a champagne-like flow.

NB. No reliance should be placed on dimensions given, which are for guidance only. For full specifications on all Franke products visit [www.franke.co.uk](http://www.franke.co.uk)

## Franke Triflow

Franke Triflow Kubus		Franke Triflow Olympus		Franke Triflow Doric	
(1) 6	 <p><b>Tap Height:</b> 367 <b>Spout Reach:</b> 235 <b>Base Diameter:</b> 47 <b>Tap cut-out:</b> 35 <b>Finish:</b>   Chrome 120.0050.032   SilkSteel 120.0050.033</p>	(1) 6	 <p><b>Tap Height:</b> 375 <b>Spout Reach:</b> 237 <b>Base Diameter:</b> 53 <b>Tap cut-out:</b> 35 <b>Finish:</b>   Chrome 120.0050.036   SilkSteel 120.0050.037</p>	(1) 6	 <p><b>Tap Height:</b> 386 <b>Spout Reach:</b> 240 <b>Base Diameter:</b> 60 <b>Tap cut-out:</b> 35 <b>Finish:</b>   Chrome 120.0050.026   SilkSteel 120.0050.028</p>
Franke Triflow Tradition		Franke Triflow Mini			
(1) 6	 <p><b>Tap Height:</b> 295 <b>Spout Reach:</b> 210 <b>Base Diameter:</b> 60 <b>Tap cut-out:</b> 35 <b>Finish:</b>   Chrome 120.0050.014   Gold 120.0050.015   SilkSteel 120.0050.018   Nickel 120.0050.016   Nickel/Gold 120.0050.017</p>	(1) 5	 <p><b>Tap Height:</b> 200 <b>Spout Reach:</b> 82 <b>Base Diameter:</b> 38 <b>Tap cut-out:</b> 12 <b>Finish:</b>   Chrome 120.0050.040   SilkSteel 120.0050.042</p>		

## Franke Trispray

Franke Trispray Olympus		Franke Trispray Doric		Franke Trispray Corinthian		
(1) 4	 <p><b>Tap Height:</b> 386 <b>Spout Reach:</b> 240 <b>Base Diameter:</b> 60 <b>Tap cut-out:</b> 35 <b>Spray base diameter:</b> 50 <b>Spray cut-out:</b> 30 <b>Spray height:</b> 127 <b>Max depth worktop:</b> 57 <b>Finish:</b>   Chrome 120.0050.038   SilkSteel 120.0050.039</p>	(1) 4	 <p><b>Tap Height:</b> 386 <b>Spout Reach:</b> 240 <b>Base Diameter:</b> 60 <b>Tap cut-out:</b> 35 <b>Spray base diameter:</b> 50 <b>Spray cut-out:</b> 30 <b>Spray height:</b> 127 <b>Max depth worktop:</b> 57 <b>Finish:</b>   Chrome 120.0050.030   SilkSteel 120.0050.031</p>	(1) 4	 <p><b>Tap Height:</b> 375 <b>Spout Reach:</b> 230 <b>Base Diameter:</b> 60 <b>Tap cut-out:</b> 35 <b>Spray base diameter:</b> 50 <b>Spray cut-out:</b> 30 <b>Spray height:</b> 127 <b>Max depth worktop:</b> 57 <b>Finish:</b>   Chrome 120.0050.025</p>	
Franke Trispray Tradition						
(1) 4	 <p><b>Tap Height:</b> 295 <b>Spout Reach:</b> 210 <b>Base Diameter:</b> 60 <b>Tap cut-out:</b> 35 <b>Spray base diameter:</b> 50 <b>Spray cut-out:</b> 30 <b>Spray height:</b> 127 <b>Max depth worktop:</b> 57 <b>Finish:</b>   Chrome 120.0050.019</p>					

(1) Ceramic disc tap – may require a 4 metre head of water in a conventional plumbing system. (2) Compression valve tap – usually suitable for any plumbing system. In some instances, pull-out nozzle and spray taps may require additional pumping or local authority approval prior to installation.

Franke strongly recommends that you consult your supplier/installer prior to purchase.

1 The figure in the symbol is designed to indicate the relative flow rate performance for each tap. The rate is graded 1-8 where 1 is poor and 8 is excellent. Relative flow rates are only likely to be relevant in installations with a low head of water (below 4 metres) or low cold supply pressure. In either case you would be well advised to consult your supplier or installer.

All Franke taps are designed to conform to Water Research Council requirements and are backed by nationwide servicing and guarantees.

P Indicates tap is fitted with a Perlator® providing a champagne-like flow.

NB. No reliance should be placed on dimensions given, which are for guidance only. For full specifications on all Franke products visit [www.franke.co.uk](http://www.franke.co.uk)

Franke\* Triflow\*\* are registered trademarks of \*Franke and \*\*Triflow Concepts Ltd respectively.

All prices inclusive of V.A.T

## Soap Dispenser

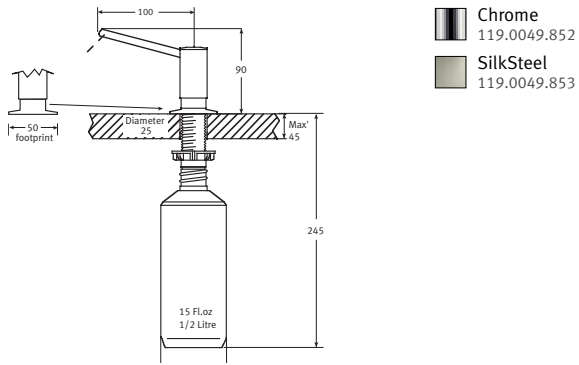

## Inset Waste Bin

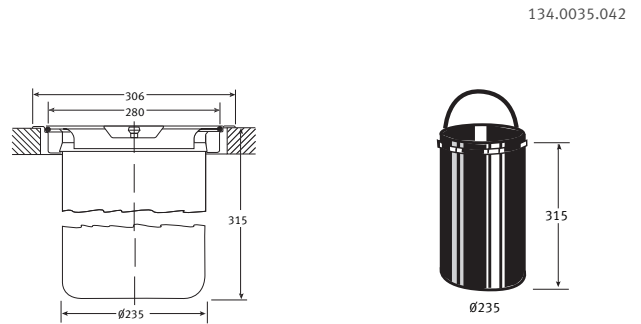

## Waste Disposers

**Franke Turbo WD-500**  
134.0049.848

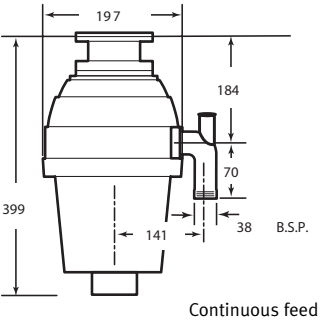

**Franke Turbo WD-751**  
134.0049.849

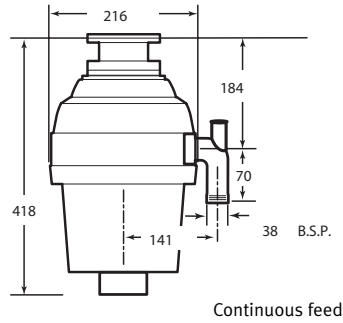

**Franke Turbo WD-1001**  
134.0049.850

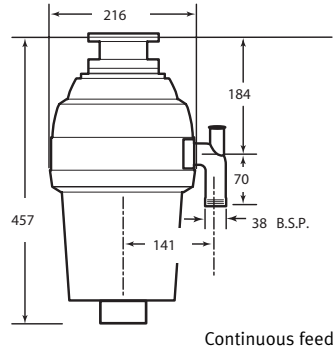

**Franke Turbo WD-1001B**  
134.0049.851

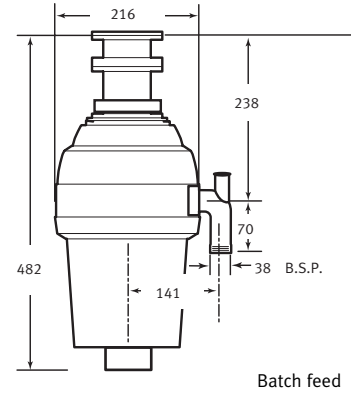

## Sorters – Soft-close drawer systems

Sorter 350-50

121.0033.259

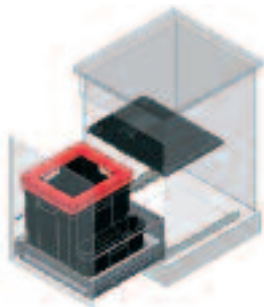
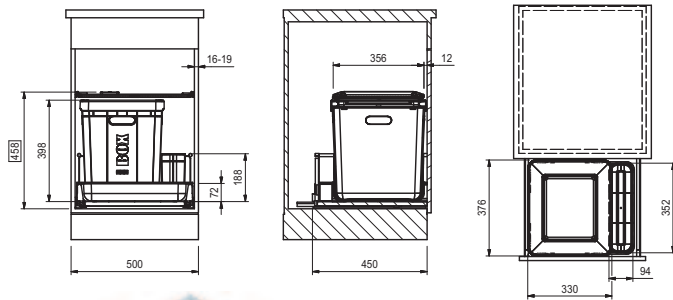

Minimum Cabinet Size 500mm

When fitting under the sink (particularly undermounts) ensure that the dimensions can be accommodated.

Sorter 350-60

121.0033.227

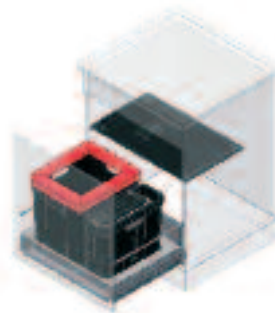
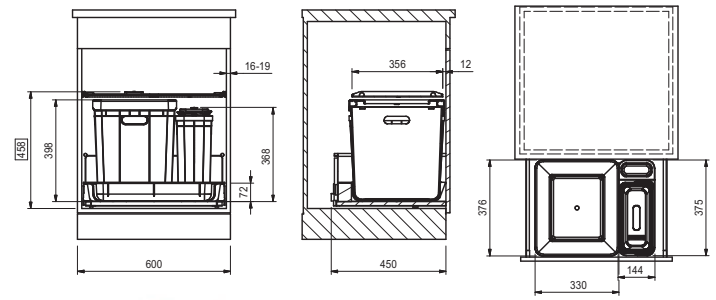

Collect Bag  
133.0038.258

Minimum Cabinet Size 600mm

When fitting under the sink (particularly undermounts) ensure that the dimensions can be accommodated.

Sorter Solo 50

121.0030.542

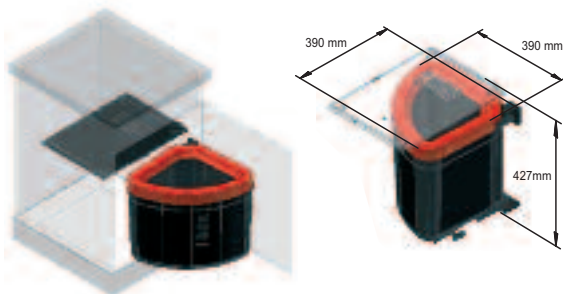
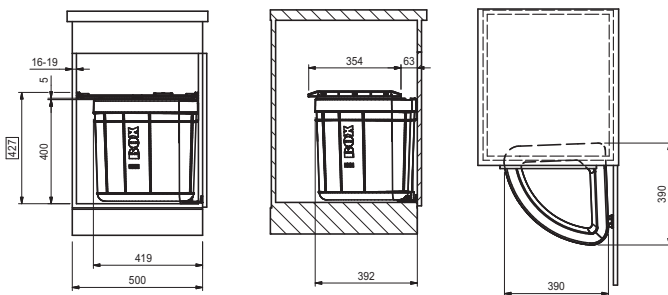

Minimum Cabinet Size 500mm

When fitting under the sink (particularly undermounts) ensure that the dimensions can be accommodated.

Sorter Solo 60

121.0033.246

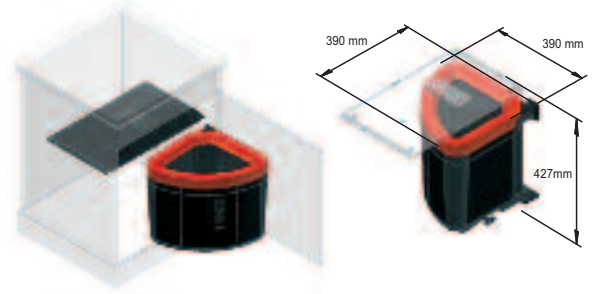
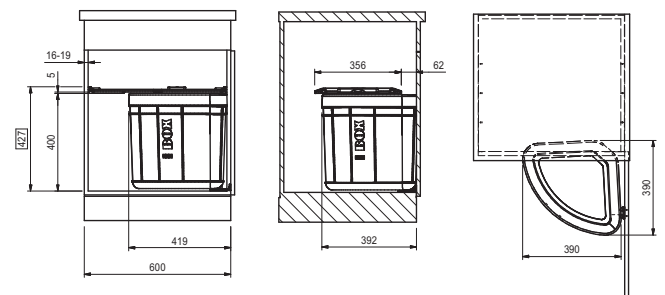

Minimum Cabinet Size 600mm

When fitting under the sink (particularly undermounts) ensure that the dimensions can be accommodated.

## Sorter – Standard door systems

Sorter 700 K 45/M 45

Sorter 700M  
(Motion) 45  
121.0007.502

Sorter 700K  
(KickMatic)45  
121.0007.499

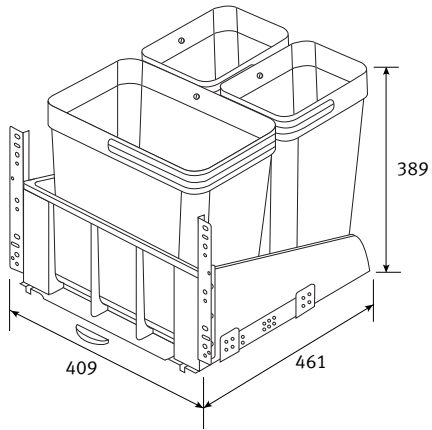

Sorter 700 K 60/M 60

Sorter 700M  
(Motion) 60  
121.0007.504

Sorter 700K  
(KickMatic)60  
121.0007.501

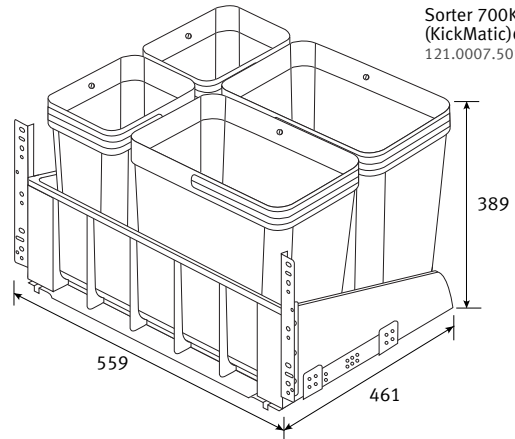

When fitting under the sink (particularly undermounts) ensure that the dimensions can be accommodated.







# Franke product brochures all downloadable from [www.franke.co.uk](http://www.franke.co.uk)

A wealth of Franke expertise and information is available to you via our extensive suite of brochures. They're on hand to inform and inspire you – request yours today.

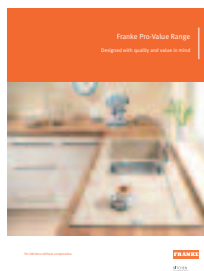

## Pro-Value Range Brochure 994.0067.753

Providing classic Franke quality in Propacks – complementary sink and tap styles in affordable packages. No corners cut, just fantastic Franke products at a reasonable price.

Downloadable and available on request

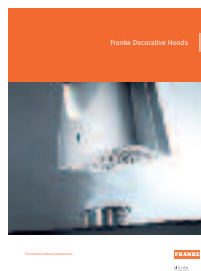

## Decorative Hoods Brochure 994.0067.759

All the new Franke hoods in one brochure – high performance appliances with precision engineering. Franke hoods make a stunning addition to any modern kitchen.

Downloadable and available on request

All brochures are downloadable from [www.franke.co.uk](http://www.franke.co.uk) or phone the consumer brochure line **0161 436 0209** to get your copy now.

Colours shown are for reference only. All sinks available with left or right hand drainer. The description 'reversible' means that the design enables the same sink to be turned to drainer on the left or drainer on the right. In the case of a 'handed' sink it is necessary to specify which side the drainer is required e.g. ARX 654 left hand drainer or ARX 654 right hand drainer. All bowls sizes and dimensions are described in mm.



In line with Franke's environmentally friendly policy all our wooden food preparation platters are made from sustainable forests, and are FSC Certified. The FSC is an independent organisation that sets the standards for environmentally responsible forest management.

**50 Year Guarantee** Franke sinks are guaranteed against manufacturing defect for 50 years. Franke taps are guaranteed against defective materials and workmanship for 1 year in relation to coatings and finishes, and 5 years in relation to moving parts. Franke will replace (and where appropriate repair) defective sinks. In relation to taps, Franke will, where appropriate, provide replacement parts for your taps or replace your taps at their discretion. Any associated or ancillary costs to be incurred by you as a result of replacement of Franke sinks and taps under this guarantee shall in all cases be previously approved by Franke UK Limited. This guarantee is in addition to and does not affect your statutory rights.

This literature has been produced on chlorine free materials harvested from sustainable forests. The Franke policy is one of continual improvement and Franke reserves the right to alter models and specifications without notice. E & OE.

Member of REPIC for WEEE Regulations. EEE Producer Registration Number - WEE/DG0059TT.

Front cover shows Kubus KBX 120 34-34 sink with Swiss Pro Chrome tap. Q-Stone® Pure White worktop - supplied by Cheshire Marble, Altrincham.

KAL Group Ltd

4078 Kingswood Road

Citywest Business Campus

Dublin 24

Telephone 01 413 6400

Freefax 1800 219 219

[info@kal.ie](mailto:info@kal.ie)

[www.kal.ie](http://www.kal.ie)

[www.franke.ie](http://www.franke.ie)

994.0067.757

SP 8/03/09

